

PREISLISTE



2023

BILDPREISLISTE

Valena™ Life, Valena™ Allure, Valena™ Life/Allure with Netatmo,
Creo™, Galea™ Life, Niloe™ Step
Gültig ab 01.12.2022

Unverbindliche Preisempfehlungen Valena™ Life / Allure, Valena™ with Netatmo, Galea™ Life, Creo™, Niloe™ Step

2023

Gültig ab 01.12.2022

Diese Preisliste ersetzt alle bisher erschienenen
Unterlagen mit Preisangaben.
Änderungen und Irrtümer vorbehalten.

Lieferungen

erfolgen zu unseren jeweils gültigen Liefer- und
Zahlungsbedingungen.

Alle Artikelstammdaten

mit dazugehörigen Preisen sind auch auf folgender
Website verfügbar: www.legrand.de.

Erklärung der Kurzbezeichnungen

Erklärung der Rabattgruppen (RG):

- 13..... Kernartikel Valena™ Life
- 14..... IN'MATIC Mechanik
- 15..... IN'MATIC Elektronik
- 16..... Design Valena™ Life
- 17..... Design Valena™ Allure
- 19..... Valena™ Life/Allure with Netatmo
- 56..... My Home Gebäudeautomation
- 21..... Schalter PRO 21™ Einsatz
- 21, 22, 24.... Creo™
- 21, 23, 24.... Galea™ Life
- 29..... Schalterprogramm Mosaic™
- 26, 27..... Schalterprogramm Niloe™
- 26, 27..... Niloe™ Step
- 43..... Schalter Sonstiges
- 31..... Hauselektronik

Best.-Nr.:

Bestellnummer

Preise:

Unverbindliche Preisempfehlung in Euro per Stück
(außer anders angegeben), exkl. MwSt.

RG:

Rabattgruppe

Allgemeine Lieferbedingungen:

Es gelten unsere Allgemeinen Lieferbedingungen in der
jeweils aktuellen Fassung, die Sie unter www.legrand.de
im Internet abrufen können.

Inhalt

Kalkulationshilfen – Komplettgeräte	2
Valena™ Life	8
Valena™ Allure	24
Valena™ Life/Allure with Netatmo	42
Creo™	48
Galea™ Life	66
Niloe™ Step	86

VALENATTM LIFE

Kalkulationshilfe

Einzelgerät komplett

Einsatz + Wippe/Abdeckung + Rahmen

Preise in Euro

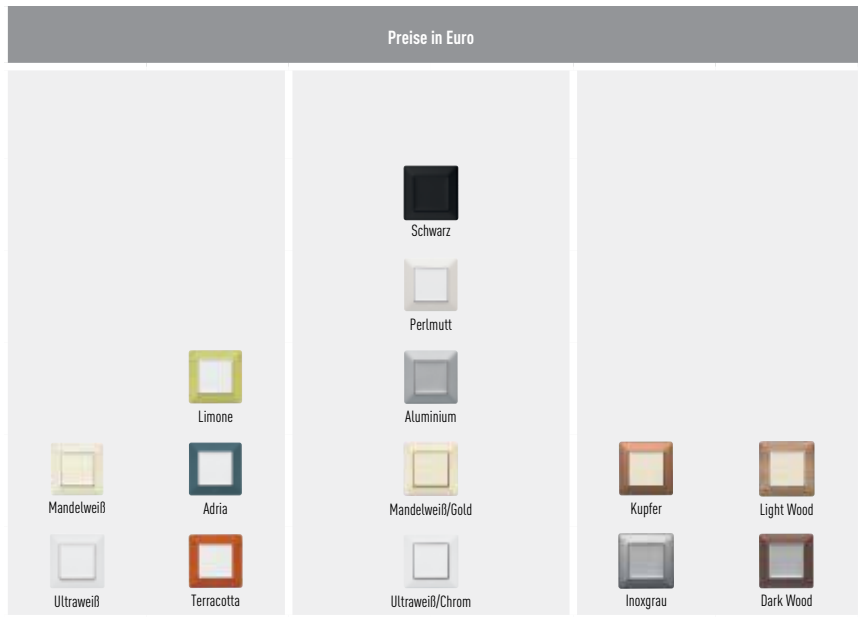

Bezeichnung der Komplettgeräte				
Schalter/Taster	Aus-/Wechselschalter	17,03 20,27	18,55 22,07	19,48 23,18
	Kreuzschalter	26,99 32,12	28,51 33,93	29,44 35,03
	Serienschalter	25,76 30,65	27,28 32,46	28,21 33,57
	Doppelwechselschalter	36,46 43,39	37,98 45,20	38,91 46,30
	Jalousieschalter/-taster	39,47 46,97	40,99 48,78	41,92 49,88
	Aus-/Wechselschalter Kontroll/beleuchtet	36,15 43,02	37,67 44,83	38,60 45,93
	Taster, 1-polig (Schließer)	18,34 21,82	19,86 23,63	20,79 24,74
	with Netatmo	Schalter/Dimmer with Netatmo	71,90 85,56	74,20 88,30
Rollladenschalter with Netatmo		68,35 81,34	71,95 85,62	73,87 87,91
MyHOME	Unterputz-Aktor, 2-fach	91,79 109,23	93,31 111,04	94,24 112,15
	Tastsensor, 2-fach	69,99 83,29	71,51 85,10	72,44 86,20
Steckdosen	Schutzkontakt-Steckdose (SL) mit erhöhtem Berührungsschutz	9,87 11,75	11,39 13,55	12,32 14,66
	Schutzkontakt-Steckdose (SL) mit Klappdeckel	17,97 21,38	19,49 23,19	20,42 24,30
TV/Multimedia	Antennen-Einzel-/ Durchgangsdose TV-RD-SAT	36,64 43,60	38,16 45,41	39,09 46,52
	RJ45-Datendose Kat 6 A, 2-fach	46,16 54,93	47,68 56,74	48,61 57,85
Elektronik	Bewegungsmelder 2-Leiter	135,40 161,13	136,92 162,93	137,85 164,04
	Bewegungsmelder 3-Leiter	54,35 64,68	55,87 66,49	56,80 67,59
	Drehdimmer	62,46 74,33	63,98 76,14	64,91 77,24
	LED-Tastdimmer	130,21 154,95	131,73 156,76	132,66 157,87
Zubehör	Blindabdeckung	14,22 16,92	15,74 18,73	16,67 19,84
	Wireless Charging-Ladestation	111,37 132,53	112,89 134,34	113,82 135,45

VALENA™ ALLURE

Kalkulationshilfe

Einzelgerät komplett

Einsatz + Wippe/Abdeckung + Rahmen

Preise in Euro



Bezeichnung der Kompletteräte	In Ausführung: Wippe Ultraweiß, Mandelweiß				In Ausführung: Wippe farbig			
Schalter/Taster	Aus-/Wechselschalter	22,92 27,27	32,85 39,09	51,80 61,64	78,50 93,42	26,75 31,83	54,00 64,26	80,70 96,03
	Kreuzschalter	32,88 39,13	42,81 50,94	61,76 73,49	88,46 105,27	36,71 43,68	63,96 76,11	90,66 107,89
	Serienschalter	30,82 36,68	40,75 48,49	59,70 71,04	86,40 102,82	34,25 40,76	61,50 73,19	88,20 104,96
	Doppelwechselschalter	41,52 49,41	51,45 61,23	70,40 83,78	97,10 115,55	44,95 53,49	72,20 85,92	98,90 117,69
	Jalousieschalter/-taster	46,02 54,76	55,95 66,58	74,90 89,13	101,60 120,90	49,95 59,44	77,20 91,87	103,90 123,64
	Aus-/Wechselschalter Kontroll/beleuchtet	42,22 50,24	52,15 62,06	71,10 84,61	97,80 116,38	45,40 54,03	72,65 86,45	99,35 118,23
	Taster, 1-polig (Schließer)	24,23 28,83	34,16 40,65	53,11 63,20	79,81 94,97	28,06 33,39	55,31 65,82	82,01 97,59
with Netatmo	Schalter/Dimmer with Netatmo	71,90 85,56	87,35 103,95	106,30 126,50	133,00 158,27	74,20 88,30	108,60 129,23	135,30 161,01
	Rollladenschalter with Netatmo	68,35 81,34	83,80 99,72	102,75 122,27	129,45 154,05	71,95 85,62	106,35 126,56	133,05 158,33
MyHOME	Unterputz-Aktor, 2-fach	101,00 120,19	110,93 132,01	129,88 154,56	156,58 186,33	105,73 125,82	132,98 158,25	159,68 190,02
	Tastensor, 2-fach	79,20 94,25	89,13 106,06	108,08 128,62	134,78 160,39	83,93 99,88	111,18 132,30	137,88 164,08
Steckdosen	Schutzkontakt-Steckdose (SL) mit erhöhtem Berührungsschutz	15,39 18,31	25,32 30,13	44,27 52,68	70,97 84,45	20,30 24,16	47,55 56,58	74,25 88,36
	Schutzkontakt-Steckdose (SL) mit Klappdeckel	23,17 27,57	33,10 39,39	52,05 61,94	78,75 93,71			
TV/Multimedia	Antennen-Einzel-/ Durchgangsdose TV-RD-SAT	42,32 50,36	52,25 62,18	71,20 84,73	97,90 116,50	45,25 53,85	72,50 86,28	99,20 118,05
	RJ45-Datendose Kat 6 A, 2-fach	50,88 60,55	60,81 72,36	79,76 94,91	106,46 126,69	55,20 65,69	82,45 98,12	109,15 129,89
Elektronik	Bewegungsmelder 2-Leiter	147,32 175,31	157,25 187,13	176,20 209,68	202,90 241,45	152,70 181,71	179,95 214,14	206,65 245,91
	Bewegungsmelder 3-Leiter	66,27 78,86	76,20 90,68	95,15 113,23	121,85 145,00			
	Drehdimmer	71,77 85,41	81,70 97,22	100,65 119,77	127,35 151,55	77,95 92,76	105,20 125,19	131,90 156,96
	LED-Tastdimmer	139,77 166,33	149,70 178,14	168,65 200,69	195,35 232,47	146,35 174,16	173,60 206,58	200,30 238,36
Zubehör	Blindabdeckung	19,07 22,69	29,00 34,51	47,95 57,06	74,65 88,83	25,35 30,17	52,60 62,59	79,30 94,37
	Wireless Charging-Ladestation	113,82 135,45	123,75 147,26	142,70 169,81	169,40 201,59	115,45 137,39	142,70 169,81	169,40 201,59

GALEA™ LIFE

Kalkulationshilfe

Einzelgerät komplett
Einsatz + Wippe/Abdeckung +
Rahmen

Preise in Euro



Bezeichnung der Komplettgeräte			
Schalter/Taster	Aus-/Wechselschalter	23,39 27,83	27,30 32,49
	Kreuzschalter	33,55 39,92	37,46 44,58
	Serienschalter	31,37 37,33	34,92 41,55
	Doppelwechselschalter	42,32 50,36	45,87 54,59
	Jalousieschalter/-taster	47,92 57,02	51,92 61,78
	Aus-/Wechselschalter Kontroll/beleuchtet	40,50 48,20	43,77 52,09
	Taster, 1-polig (Schließer)	24,75 29,45	28,66 34,11
	with Netatmo	Schalter/Dimmer with Netatmo	
Rollladenschalter with Netatmo			
MyHOME	Unterputz-Aktor, 2-fach	102,00 121,38	
	Tastsensor, 2-fach	79,37 94,45	
Steckdosen	Schutzkontakt-Steckdose (SL) mit erhöhtem Berührungsschutz	19,17 22,81	23,67 28,17
	Schutzkontakt-Steckdose (SL) mit Klappdeckel	23,72 28,23	28,92 34,41
TV/Multimedia	Antennen-Einzel-/ Durchgangsdose TV-RD-SAT	43,12 51,31	46,22 55,00
	RJ45-Datendose Kat 6 A, 2-fach	58,67 69,82	62,17 73,98
Elektronik	Bewegungsmelder 2-Leiter	197,77 235,35	165,07 196,43
	Bewegungsmelder 3-Leiter	165,57 197,03	83,47 99,33
	Drehdimmer	65,22 77,61	71,67 85,29
	LED-Tastdimmer	150,57 179,18	157,27 187,15
Zubehör	Blindabdeckung	19,47 23,17	25,87 30,79
	Wireless Charging-Ladestation		

CREO™

Kalkulationshilfe

Einzelgerät komplett
Einsatz + Wippe/Abdeckung +
Rahmen

Preise in Euro

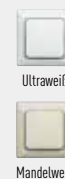

Bezeichnung der Komplettgeräte		
Schalter/Taster	Aus-/Wechselschalter	17,46 20,78
	Kreuzschalter	27,62 32,87
	Serienschalter	26,50 31,54
	Doppelwechselschalter	37,45 44,57
	Jalousieschalter/-taster	41,61 49,52
	Aus-/Wechselschalter Kontroll/beleuchtet	34,55 41,11
	Taster, 1-polig (Schließer)	18,82 22,40
	with Netatmo	Schalter/Dimmer with Netatmo
Rollladenschalter with Netatmo		
MyHOME	Unterputz-Aktor, 2-fach	96,13 114,39
	Tastsensor, 2-fach	73,50 87,47
Steckdosen	Schutzkontakt-Steckdose (SL) mit erhöhtem Berührungsschutz	13,19 15,70
	Schutzkontakt-Steckdose (SL) mit Klappdeckel	18,36 21,85
TV/Multimedia	Antennen-Einzel-/ Durchgangsdose TV-RD-SAT	37,45 44,57
	RJ45-Datendose Kat 6 A, 2-fach	52,10 62,00
Elektronik	Bewegungsmelder 2-Leiter	195,36 232,48
	Bewegungsmelder 3-Leiter	163,16 194,16
	Drehdimmer	55,39 65,91
	LED-Tastdimmer	141,18 168,00
Zubehör	Blindabdeckung	22,14 26,35
	Wireless Charging-Ladestation	

NILOE™ STEP, MOSAIC™, SOLIROC™

Kalkulationshilfe

Einzelgerät komplett
Einsatz + Wippe/Abdeckung + Rahmen

Preise in Euro			
Soliroc™ Unterputz IP 55/IK 10 vandalensicher	Mosaic™ Unterputz	NiloE™ Step Unterputz	
Grau	Weiß	Schwarz	Aluminium





Bezeichnung der Komplettgeräte					
Schalter/Taster	Aus-/Wechselschalter	101,97 121,34	16,98 20,21	14,49 17,24	17,15 20,41
	Kreuzschalter	114,92 136,75	26,98 32,11	23,60 28,08	27,59 32,83
	Serienschalter		24,02 28,58	21,08 25,09	25,15 29,93
	Doppelwechselschalter		24,02 28,58	20,08 23,90	24,15 28,74
	Jalousieschalter/-taster	253,22 301,33	39,93 47,52	33,04 39,32	38,86 46,24
	Aus-/Wechselschalter Kontrolle/beleuchtet	118,67 141,22	25,42 30,25	19,77 23,53	19,37 23,05
	Taster, 1-polig (Schließer)	100,12 119,14	17,93 21,34	15,51 18,46	18,17 21,62
with Netatmo	Schalter/Dimmer with Netatmo				
	Rollladenschalter with Netatmo				
MyHOME	Unterputz-Aktor, 2-fach				
	Tastensor, 2-fach				
Steckdosen	Schutzkontakt-Steckdose (SL) mit erhöhtem Berührungsschutz	89,12 106,05	10,01 11,91	8,28 9,85	12,40 14,76
	Schutzkontakt-Steckdose (SL) mit Klappdeckel	114,27 135,98	19,13 22,76	14,78 17,59	22,21 26,43
TV/Multimedia	Antennen-Einzel-/ Durchgangsdose TV-RD-SAT	115,67 137,65	30,33 36,09	28,05 33,38	33,16 39,46
	RJ45-Datendose Kat 6 A, 2-fach		38,48 45,79	40,74 48,48	44,89 53,42
Elektronik	Bewegungsmelder 2-Leiter	202,47 240,94	128,63 153,07	117,94 140,35	123,11 146,50
	Bewegungsmelder 3-Leiter	133,97 159,42	51,38 61,14	48,54 57,76	53,71 63,91
	Drehdimmer			73,64 87,63	78,81 93,78
	LED-Tastdimmer		136,28 162,17	121,44 144,51	126,91 151,02
Zubehör	Blindabdeckung	95,17 113,25	10,79 12,84	11,78 14,02	17,66 21,02
	Wireless Charging-Ladestation	62,30 74,14	110,53 131,53	100,13 119,15	101,41 120,68

FEUCHTRAUM

Kalkulationshilfe

Einzelgerät komplett

Einsatz + Wippe/Abdeckung + Rahmen

Preise in Euro			
Valena™ Life Unterputz	Creo™ Unterputz	Galea™ Life Unterputz	Plexo™ 55 Aufputz
			
Ultraweiß	Ultraweiß	Ultraweiß	Grau

Bezeichnung der Komplettgeräte					
Schalter/Taster	Aus-/Wechselschalter	26,02 30,96	26,71 31,78	36,52 43,46	16,80 19,99
	Kreuzschalter			46,52 55,36	26,70 31,77
	Serienschalter	31,02 36,91	31,61 37,62	45,12 53,69	27,50 32,73
	Doppelwechselschalter	31,02 36,91	39,41 46,90	54,77 65,18	33,20 39,51
	Jalousieschalter/-taster			60,12 71,54	40,00 47,60
	Aus-/Wechselschalter Kontroll/beleuchtet		53,91 64,15	59,12 70,35	31,10 37,01
	Taster, 1-polig (Schließer)	27,32 32,51	27,81 33,09	39,87 47,45	16,80 19,99
with Netatmo	Schalter/Dimmer with Netatmo				
	Rollladenschalter with Netatmo				
MyHOME	Unterputz-Aktor, 2-fach				
	Tastsensor, 2-fach				
Steckdosen	Schutzkontakt-Steckdose (SL) mit erhöhtem Berührungsschutz				
	Schutzkontakt-Steckdose (SL) mit Klappdeckel	24,42 29,06	24,81 29,52	33,57 39,95	13,40 15,95
TV/Multimedia	Antennen-Einzel-/ Durchgangsdose TV-RD-SAT				
	RJ45-Datendose Kat 6 A, 2-fach				
Elektronik	Bewegungsmelder 2-Leiter	151,07 179,77			140,08 166,70
	Bewegungsmelder 3-Leiter				57,78 68,76
	Drehdimmer				
	LED-Tastdimmer				
Zubehör	Blindabdeckung				
	Wireless Charging-Ladestation				



























VALENA™



VALENA LIFE/ALLURE

TRANSFORM
YOUR DAILY LIFE



















Funktion	VALENA IN'MATIC EINSATZ	VALENA LIFE ABDECKUNGEN			
		Ultraweiß 	Mandelweiß 	Aluminium 	Schwarz 
SCHALTER 10 AX – 250 V~					
Wechselschalter	 752006 € 9,79 [13]	755000 € 4,17 [13]	755001 € 4,17 [13]	755002 € 4,05 [16]	756002 € 4,05 [16]
Wechselschalter mit N-Klemme	 752010 € 20,85 [14]				
Kontroll-Wechselschalter mit N-Klemme	 752010 + 067688 € 20,85 + € 6,70 [14] [29]	755100 € 5,53 [13]	755101 € 5,53 [13]	755102 € 5,53 [16]	756102 € 5,53 [16]
Kreuzschalter	 752007 € 19,75 [14]	755000 € 4,17 [13]	755001 € 4,17 [13]	755002 € 4,05 [16]	756002 € 4,05 [16]
Wechselschalter, beleuchtet	  752006 + 067686 € 9,79 + € 6,70 [13] [14]	755100 € 5,53 [13]	755101 € 5,53 [13]	755102 € 5,53 [16]	756102 € 5,53 [16]
Kreuzschalter, beleuchtet	  752007 + 665090 € 19,75 + € 4,52 [14] [26]	755100 € 5,53 [13]	755101 € 5,53 [13]	755102 € 5,53 [16]	756102 € 5,53 [16]
Serienschalter	 752005 € 15,25 [13]	755020 € 7,44 [13]	755021 € 7,44 [13]	755022 € 7,44 [16]	756022 € 7,44 [16]
Doppelwechselschalter	 752008 € 25,95 [14]				
Serienschalter, beleuchtet	  752005 + 2 x 067684 € 15,25 + 2 x € 4,38 [13] [14]	755220 € 10,75 [16]	755221 € 10,75 [16]	755222 € 10,75 [16]	756222 € 10,75 [16]
Serienschalter Kontroll	  752005 + 2 x 665091 € 15,25 + 2 x € 4,52 [13] [26]				
Doppelwechselschalter, beleuchtet	  752008 + 2 x 067686 € 25,95 + 2 x € 6,70 [14] [14]				
3-fach Ausschalter	 752003 € 27,95 [14]	755030 € 10,75 [16]	755031 € 10,75 [16]	755032 € 10,75 [16]	756032 € 10,75 [16]
2-poliger Ausschalter	 752004 € 20,10 [14]	755120 € 5,45 [16]	755121 € 5,45 [16]	755122 € 5,45 [16]	756122 € 5,45 [16]
2-poliger Ausschalter Kontroll	 752042 ⁽¹⁾ € 32,60 [14]	755040 € 6,74 [16]	755041 € 6,74 [16]	755042 € 6,74 [16]	–
SCHALTER 16 AX – 250 V~					
Wechselschalter	 752027 € 35,75 [14]	755000 € 4,17 [13]	755001 € 4,17 [13]	755002 € 4,05 [16]	756002 € 4,05 [16]
SCHALTER 20 AX – 250 V~					
2-poliger Wechselschalter	 077063L € 18,20 [29]	752144 € 5,96 [16]	–	–	–
2-poliger Wechselschalter Kontroll	 077063L + 067664 € 18,20 + € 8,67 [29] [14]	752144 € 5,96 [16]	–	–	–

1: LED Best.Nr. 665091 enthalten

Valena™ Life















Auswahltabelle für Wippen und Abdeckungen

Funktion	VALENA IN'MATIC EINSATZ	VALENA LIFE ABDECKUNGEN			
		Ultraweiß 	Mandelweiß 	Aluminium 	Schwarz 
TASTER 6 A/10A – 250 V~ und 6A – 12 V~					
Wechseltaster 6 A	 752011 € 11,10 [13]	755000 € 4,17 [13]	755001 € 4,17 [13]	755002 € 4,05 [16]	756002 € 4,05 [16]
Wechseltaster 10 A	 752012 € 11,10 [14]				
Wechseltaster 6 A, mit Glockensymbol	 752011 € 11,10 [13]	755010 € 6,30 [16]	755011 € 6,30 [16]	755012 € 6,30 [16]	756012 € 6,30 [16]
Wechseltaster 10 A, mit Glockensymbol	 752012 € 11,10 [14]				
Wechseltaster 6 A, beleuchtet	 752011 + 067686 € 11,10 + € 6,70 [13] [14]	755100 € 5,53 [13]	755101 € 5,53 [13]	755102 € 5,53 [16]	756102 € 5,53 [16]
Wechseltaster 10 A, beleuchtet	 752012 + 067686 € 11,10 + € 6,70 [14] [14]				
Wechseltaster 6 A, beleuchtet, mit Glockensymbol	 752011 + 067686 € 11,10 + € 6,70 [13] [14]	755050 € 6,74 [16]	755051 € 6,74 [16]	755052 € 6,74 [16]	–
Wechseltaster 10 A, beleuchtet, mit Glockensymbol	 752012 + 067686 € 11,10 + € 6,70 [14] [14]				
Wechseltaster 6 A, beleuchtet, mit Beschriftungsfeld	 752011 + 067686 € 11,10 + € 6,70 [13] [14]	755110 ⁽²⁾ € 7,82 [16]			
Wechseltaster 10 A, beleuchtet, mit Beschriftungsfeld	 752012 + 067686 € 11,10 + € 6,70 [14] [14]				
Doppelwechseltaster 6 A	 752018 € 26,55 [14]	755020 € 7,44 [13]	755021 € 7,44 [13]	755022 € 7,44 [16]	756022 € 7,44 [16]
Doppelwechseltaster 6 A, beleuchtet	 752018 + 2 x 067686 € 26,55 + 2 x € 6,70 [14] [14]	755220 € 10,75 [16]	755221 € 10,75 [16]	755222 € 10,75 [16]	756222 € 10,75 [16]
Taster 6 A, beleuchtet, 12 V~	 752013 ⁽³⁾ € 15,45 [14]	755100 € 5,53 [13]	755101 € 5,53 [13]	755102 € 5,53 [16]	756102 € 5,53 [16]

1: inkl. Einsatz

2: Transparente Wippe mit 3 unterschiedlichen Einlagen (Ultraweiß, Mandelweiß, Aluminium)



















3: LED Best.Nr. 067687 enthalten

Funktion	VALENA IN'MATIC EINSATZ	VALENA LIFE ABDECKUNGEN			
		Ultraweiß 	Mandelweiß 	Aluminium 	Schwarz 
ZUGTASTER, DREH- UND SCHLÜSSELSCHALTER					
Zugtaster 	–	752124 ⁽¹⁾ € 28,40 [16]	752224 ⁽¹⁾ € 28,40 [16]	752324 ⁽¹⁾ € 28,40 [16]	–
3-Stufenschalter, mit Nullstellung (0, 1, 2, 3) 	–	752132 ⁽¹⁾ € 73,25 [16]	752232 ⁽¹⁾ € 73,25 [16]	752332 ⁽¹⁾ € 73,25 [16]	–
Schlüsselschalter DIN, für DIN-Halbprofilzylinder (0, 1), nicht enthalten, in allen Stellungen abziehbar 	–	752125 ⁽¹⁾ € 92,70 [16]	–	–	–
ROLLADENSTEUERUNG					
Rollladen-/Jalousieschalter 	752029 € 26,15 [14]	755140 € 10,25 [16]	755141 € 10,25 [16]	755142 € 10,25 [16]	756142 € 10,25 [16]
Rollladen-/Jalousietaster 	752020 € 26,15 [14]				
Rollladen-/Jalousieschalter, verriegelt 	–	A75102 ⁽¹⁾ € 39,20 [16]	A75202 ⁽¹⁾ € 39,20 [16]	A75302 ⁽¹⁾ € 38,05 [16]	–
Rollladen-/Jalousietaster 	–	A75101 ⁽¹⁾ € 39,20 [16]	A75201 ⁽¹⁾ € 39,20 [16]	A75301 ⁽¹⁾ € 38,05 [16]	–
Rollladen-/Jalousieuhr Standard	–	A75103 ⁽¹⁾ € 127,10 [15]	–	–	–
Rollladen-/Jalousieuhr Astro	–	A75104 ⁽¹⁾ € 145,90 [15]	–	–	–
Jalousie-Schlüsseltaster DIN, für DIN-Halbprofilzylinder (0, 1), nicht enthalten, in allen Stellungen abziehbar 	077075 € 90,80 [29]	752144 € 5,96 [16]	–	752344 € 5,96 [16]	–
DIMMER					
LED-Universal-Drehdimmer, 300 W ohne Neutralleiter, Phasen-/abschnitt 	752060 € 50,90 [15]	754880 € 8,49 [16]	754881 € 8,49 [16]	754882 € 8,49 [16]	756882 € 8,49 [16]
LED-Universal-Tastdimmer, 400 W ohne Neutralleiter, Phasen-/abschnitt 	752062 € 118,05 [15]	754890 € 9,09 [16]	754891 € 9,09 [16]	754892 € 9,09 [16]	756892 € 9,09 [16]
Tastdimmer 1 – 10 V, Steuerstrom 40 mA DC, Schaltleistung max. 600 VA 	752067 € 64,35 [15]				

1: inkl. Einsatz

Valena™ Life

Auswahltabelle für Wippen und Abdeckungen

Funktion	VALENA IN'MATIC EINSATZ	VALENA LIFE ABDECKUNGEN				
		Ultraweiß 	Mandelweiß 	Aluminium 	Schwarz 	
BEWEGUNGSMELDER						
Bewegungsmelder 2-Leiter 180°, mit/ohne Handschalter, parallelschaltbar		–	A75212 ⁽¹⁾ € 192,15 [15]	A75222 ⁽¹⁾ € 192,15 [15]	A75232 ⁽¹⁾ € 192,15 [15]	–
Bewegungsmelder 3-Leiter 180°, mit/ohne Handschalter, parallelschaltbar, Nebenstelleneingang		–	A75213 ⁽¹⁾ € 159,95 [15]	A75223 ⁽¹⁾ € 159,95 [15]	A75233 ⁽¹⁾ € 159,95 [15]	–
Bewegungsmelder 2-Leiter, 120°, 250 W⁽²⁾		752070 € 125,80 [15]	754884 € 6,53 [16]	754893 € 6,53 [16]	754894 € 6,53 [16]	A75694 € 6,48 [16]
Bewegungsmelder 3-Leiter, 120°, 400 W⁽³⁾		752073 € 44,75 [15]				
Bewegungsmelder 2-Leiter mit Handschalter, 120°, 250 W⁽²⁾		–	752172 ⁽¹⁾ € 155,05 [15]	752272 ⁽¹⁾ € 155,05 [15]	752372 ⁽¹⁾ € 155,05 [15]	–
Stufenbeleuchtung mit Bewegungsmelder, 120°		–	752174 ⁽¹⁾ € 122,45 [15]	–	–	–
ZEIT-/NACHLAUF- UND KARTENSCHALTER						
Nachlaufschalter		752032 € 170,30 [14]	755210 € 5,53 [16]	755211 € 5,53 [16]	755212 € 5,53 [16]	–
Zeitschalter elektronisch		752061 € 118,05 [15]				
Zeitschalter 0 – 15 Minuten		–	A75105 ⁽¹⁾ € 84,20 [16]	A75205 ⁽¹⁾ € 84,20 [16]	A75305 ⁽¹⁾ € 84,20 [16]	–
Zeitschalter 0 – 120 Minuten		–	A75106 ⁽¹⁾ € 90,00 [16]	A75206 ⁽¹⁾ € 90,00 [16]	A75306 ⁽¹⁾ € 90,00 [16]	–
Hotel-Card-Schalter		752025 € 41,05 [14]	755160 € 29,15 [16]	755161 € 29,15 [16]	755162 € 29,15 [16]	755168 € 36,30 [17]
MOBILE LEUCHE						
Herausnehmbare Leuchte		–	752069 ⁽¹⁾ € 112,00 [15]	752169 ⁽¹⁾ € 112,00 [15]	752269 ⁽¹⁾ € 112,00 [15]	–
LÄUTEWERKE						
Gong 12 V~		–	A75111 ⁽¹⁾ € 83,65 [16]	–	–	–
Gong 230 V~		–	A75112 ⁽¹⁾ € 86,30 [16]	–	–	–

1: inkl. Einsatz

2: Für folgende Lastarten geeignet:

- Glüh- und HV-Halogenlampen: 3–250 W

- LEDs, Leuchtstoff- und Kompaktleuchtstofflampen und NV-Halogenlampen mit elektronischem oder konventionellem Vorschaltgerät: –250 VA

- LED- oder Kompaktleuchtstofflampen: 3–100 W, Parallelschaltung mehrerer Bewegungsmelder möglich, (max. 2 zusätzliche Sensoren).

Die Einstellungen werden mittels Potentiometer durchgeführt.

















3: Für folgende Lastarten geeignet:

- Glüh- und HV-Halogenlampen: bis 400 W

- LEDs, Leuchtstoff- und Kompaktleuchtstofflampen und NV-Halogenlampen mit elektronischem oder konventionellem Vorschaltgerät: bis 200 VA

- LED- oder Kompaktleuchtstofflampen: bis 50 W, Parallelschaltung mehrerer Bewegungsmelder möglich.















Die Einstellungen werden mittels Potentiometer durchgeführt.

Funktion	VALENA IN'MATIC EINSATZ	VALENA LIFE ABDECKUNGEN			
		Ultraweiß 	Mandelweiß 	Aluminium 	Schwarz 
THERMOSTATE					
Elektronisches Raumthermostat 	-	752133 ⁽¹⁾ € 115,05 [15]	752233 ⁽¹⁾ € 115,05 [15]	752333 ⁽¹⁾ € 115,05 [15]	756333 ⁽¹⁾ € 115,05 [15]
Fussboden-Raumthermostat 	-	752134 ⁽¹⁾ € 219,40 [15]	752234 ⁽¹⁾ € 219,40 [15]	752334 ⁽¹⁾ € 219,40 [15]	756334 ⁽¹⁾ € 219,40 [15]
BESCHALLUNG					
Bluetooth-Modul 	752036 € 167,50 [15]	755430 € 11,15 [16]	755431 € 11,15 [16]	755432 € 11,15 [16]	756763 € 11,15 [16]
UP-Radio mit Display	-	A75109 ⁽¹⁾ € 193,40 [15]	A75209 ⁽¹⁾ € 193,40 [15]	A75309 ⁽¹⁾ € 193,40 [15]	-
UP-Lautsprecher	-	A75110 ⁽¹⁾ € 35,75 [16]	A75210 ⁽¹⁾ € 35,75 [16]	A75310 ⁽¹⁾ € 35,75 [16]	-
STECKDOSEN 16 A MIT STECKKLEMMEN UND ERHÖHTEM BERÜHRUNGSSCHUTZ					
Steckdose 	-	753109 ⁽¹⁾ € 6,80 [13]	753209 ⁽¹⁾ € 6,80 [13]	753309 ⁽¹⁾ € 6,80 [16]	756309 ⁽¹⁾ € 6,80 [16]
Steckdose mit Klappdeckel 	-	753117 ⁽¹⁾ € 14,90 [16]	753217 ⁽¹⁾ € 14,90 [16]	753317 ⁽¹⁾ € 14,90 [16]	753109 + 756842 € 6,80 + € 15,00 [13] [16]
FR-Steckdose IP 44 	-	753119 ⁽¹⁾ € 21,35 [16]	-	-	-
Kombinationssteckdose mit USB-C (für 1-fach Rahmen), 1500 mA 	-	753135 ⁽¹⁾ € 66,55 [15]	753235 ⁽¹⁾ € 66,55 [15]	753335 ⁽¹⁾ € 66,55 [15]	756335 ⁽¹⁾ € 66,55 [15]
Steckdose Rot 	-	753129 (Farbe Rot) ⁽¹⁾ € 16,50 [16]			-
Steckdose Orange 	-	753229 (Farbe Orange) ⁽¹⁾ € 16,50 [16]			-
Steckdose Grün 	-	753329 (Farbe Grün) ⁽¹⁾ € 16,50 [16]			-
Steckdose, verwechslungssicher 	-	753131 (Farbe Rot) ⁽¹⁾ € 31,85 [16]			-
Steckdose mit Kontrollfunktion 	753109 € 6,80 [13]	754850 + 067664 € 3,44 + € 8,67 [16] [14]	754851 + 067664 € 3,44 + € 8,67 [16] [14]	754852 + 067664 € 3,44 + € 8,67 [16] [14]	-



















1: inkl. Einsatz

Valena™ Life

Auswahltabelle für Wippen und Abdeckungen















Funktion	VALENA IN'MATIC EINSATZ	VALENA LIFE ABDECKUNGEN			
		Ultraweiß 	Mandelweiß 	Aluminium 	Schwarz 
KOMBINATIONSDAPTER					
Kombinationsadapter für 753 x 13 	–	754225 € 5,00 [16]	754235 € 5,00 [16]	754245 € 5,00 [16]	–
KABELAUSLÄSSE					
Kabelausslass mit Klemmen 	753033 € 12,50 [14]	754730 € 6,13 [16]	754731 € 6,13 [16]	754732 € 6,13 [16]	756732 € 6,13 [16]
Kabelausslass ohne Klemmen 	753034 € 10,25 [14]				
TV-R-SAT-DOSEN					
TV-R-SAT Durchgangsdose, System Legrand 	753065 € 25,85 [14]	754790 € 7,72 [16]	754791 € 7,72 [16]	754792 € 7,72 [16]	756792 € 7,72 [16]
TV-R-SAT Enddose, System Legrand 	753064 € 25,85 [14]				
TV-R-SAT Enddose, System Hirschmann 	775983 € 31,65 [21]	754800 € 6,13 [16]	754801 € 6,13 [16]	754802 € 6,13 [16]	756802 € 5,91 [16]
TV-R-DOSEN					
TV-R Einzeldose, System Hirschmann 	775981 € 26,45 [21]	754800 € 6,13 [16]	754801 € 6,13 [16]	754802 € 6,13 [16]	–
TV-R Durchgangsdose, System Hirschmann 	775984 € 29,05 [21]				
TV-R-SAT-SAT-DOSE					
TV-R-SAT-SAT 	753056 € 25,30 [14]	754810 € 7,72 [16]	754811 € 7,72 [16]	754812 € 7,72 [16]	–
ABDECKUNG TV-R-SAT-SAT					
4-Loch Abdeckung für Drittanbieter TV-R-SAT-SAT 	–	A75800 € 7,44 [16]	–	–	–

1: inkl. Einsatz

Funktion	VALENA IN'MATIC EINSATZ	VALENA LIFE ABDECKUNGEN			
		Ultraweiß 	Mandelweiß 	Aluminium 	Schwarz 
EINZELDOSE TV + RJ45					
TV-Dose 0–2400 MHz + RJ45, Kategorie 6, UTP 	753055 € 37,25 [14]	754830 € 6,54 [16]	754831 € 6,54 [16]	754832 € 6,54 [16]	756832 € 6,54 [16]
DATENDOSEN KATEGORIE 6 UND KATEGORIE 6 A					
RJ45-Datendose, Kategorie 6, UTP 	753042 € 22,20 [14]	75410 € 6,54 [16] oder 75470 € 7,44 [16] (mit Beschriftungsfeld)	75411 € 6,54 [16] oder 75471 € 7,44 [16] (mit Beschriftungsfeld)	75412 € 6,54 [16] oder 75472 € 7,44 [16] (mit Beschriftungsfeld)	756412 € 6,54 [16] oder 756472 € 7,44 [16] (mit Beschriftungsfeld)
RJ45-Datendose, Kategorie 6A, UTP 	753044 € 24,85 [14]				
RJ45-Datendose, Kategorie 6, STP 	753046 € 27,25 [14]				
RJ45-Datendose, Kategorie 6A, STP 	753048 € 30,15 [14]				
2 x RJ45-Datendose, Kategorie 6, UTP 	753043 € 30,50 [14]	75420 € 6,54 [16] oder 75480 € 7,44 [16] (mit Beschriftungsfeld)	75421 € 6,54 [16] oder 75481 € 7,44 [16] (mit Beschriftungsfeld)	75422 € 6,54 [16] oder 75482 € 7,44 [16] (mit Beschriftungsfeld)	756422 € 6,54 [16]
2 x RJ45-Datendose, Kategorie 6A, UTP 	753045 € 34,05 [13]				
2 x RJ45-Datendose, Kategorie 6, STP 	753047 € 36,55 [14]				
2 x RJ45-Datendose, Kategorie 6A, STP 	753049 € 40,95 [13]				
Kombidose RJ11 + RJ45, Kategorie 6, UTP 	753032 € 32,05 [14]				
DATENDOSEN FREMDFABRIKATE					
Rutenbeck 2 x RJ45, Kategorie 5E, UTP 	775887 € 43,95 [31]	755380 € 7,28 [16]	755381 € 7,28 [16]	755382 € 7,28 [16]	–
Rutenbeck 2 x RJ45, Kategorie 6A, STP 	775976 € 42,10 [31]				
Keystone-Adapter, 2-fach	–	755390 € 7,87 [16]	–	755392 € 7,87 [16]	–
TELEFONDOSSEN					
RJ11 Telefondose 	753038 € 21,50 [14]	755410 € 6,54 [16]	755411 € 6,54 [16]	755412 € 6,54 [16]	756412 € 6,54 [16]
2 x RJ11 Telefondose 	753039 € 23,95 [14]	755420 € 6,54 [16]	755421 € 6,54 [16]	755422 € 6,54 [16]	–
TAE / TDO Telefondose 	775991 / 775990 € 14,85 / € 48,75 [21] [21]	755490 € 5,91 [16]	755491 € 5,91 [16]	755492 € 5,91 [16]	756492 € 6,13 [16]

Valena™ Life

Auswahltabelle für Wippen und Abdeckungen









Funktion	VALENA IN'MATIC EINSATZ	VALENA LIFE ABDECKUNGEN			
		Ultraweiß 	Mandelweiß 	Aluminium 	Schwarz 
LAUTSPRECHER-ANSCHLUSSDOSEN					
Lautsprecherdose mit Federklemmen 	753072 € 16,65 [14]	755360 € 7,88 [16]	755361 € 7,88 [16]	755362 € 7,88 [16]	756362 € 7,88 [16]
Lautsprecherdose mit Federklemmen, 2-fach 	753078 € 21,00 [14]	755370 € 8,25 [16]	755371 € 8,25 [16]	755372 € 8,25 [17]	756372 € 8,25 [16]
AUDIO- UND VIDEOANSCHLUSSDOSEN					
RCA-Dose, 3-fach 	753075 € 56,00 [14]	754720 € 5,98 [16]	754721 € 5,98 [16]	754722 € 5,98 [16]	-
USB-Dose mit Kabel 	753082 € 81,35 [15]	754750 € 10,20 [16]	-	754752 € 10,20 [16]	-
HDMI-Anschlusseinheit 	-	078979L + 752144 € 82,80 + € 5,96 [29] [16]		-	-
HD15 	-	078757 + 752144 € 161,20 + € 5,96 [29] [16]		-	-
XLR-Dose weiblich 	-	078755 + 752144 € 112,10 + € 5,96 [29] [16]		-	-
USB-LADESTECKDOSEN					
Typ A+C USB-Ladedose, 2-fach, 3000 mA 	-	753106 ⁽¹⁾ € 46,45 [15]	753206 ⁽¹⁾ € 46,45 [15]	753306 ⁽¹⁾ € 46,45 [15]	756306 ⁽¹⁾ € 46,45 [15]
Typ C USB-Ladedose, 2-fach, 3000 mA 	-	753107 ⁽¹⁾ € 54,90 [15]	753207 ⁽¹⁾ € 54,90 [15]	753307 ⁽¹⁾ € 54,90 [15]	756307 ⁽¹⁾ € 54,90 [15]
Typ A USB-Ladedose, 2-fach, 3000 mA 	-	753112 ⁽¹⁾ € 44,80 [15]	753212 ⁽¹⁾ € 44,80 [15]	753312 ⁽¹⁾ € 44,80 [15]	756312 ⁽¹⁾ € 44,80 [15]
WIRELESS CHARGING FÜR UNTERPUTZ-DOSEN					
Wireless Charging 1000 mA Wireless Charging 2400 mA USB Typ A 	-	753114 ⁽¹⁾⁽²⁾ € 108,30 [15]			

1: inkl. Einsatz

2: wird in der Farbe Schwarz / Aluminium geliefert















Valena™ Life

Auswahltabelle für Wippen und Abdeckungen

Funktion	VALENA IN'MATIC EINSATZ	VALENA LIFE ABDECKUNGEN				
		Ultraweiß 	Mandelweiß 	Aluminium 	Schwarz 	
ZUBEHÖR						
Aufputzgehäuse, 1-fach		–	754191 € 11,80 [16]	754201 € 11,80 [16]	754211 € 11,80 [16]	754066 € 11,80 [16]
Aufputzgehäuse, 2-fach		–	754192 € 21,50 [16]	754202 € 21,50 [16]	754212 € 21,50 [16]	754067 € 21,50 [16]
Blindabdeckung		–	755180 € 11,15 [16]	755181 € 11,15 [16]	755182 € 11,15 [16]	754068 € 11,15 [16]
Zwischenring 50 x 50		–	752143 € 3,36 [16]	752243 € 3,36 [16]	752343 € 3,36 [16]	–
Mosaic™-Adapter		–	752144 € 5,96 [16]	–	752344 € 5,96 [16]	–

Valena™ Life

Auswahltabelle für Wippen und Abdeckungen







Funktion	VALENA IN'MATIC EINSATZ	VALENA LIFE ABDECKUNGEN			
		Ultraweiß 	Mandelweiß 	Aluminium 	Schwarz 
FEUCHTRAUM-SCHALTER IP 44					
Wechselschalter 10 AX 	-	752156 ⁽¹⁾⁽²⁾ € 22,95 [16]	-	-	-
Wechselschalter 10 AX, beleuchtet 	-	752167 ⁽¹⁾⁽²⁾ € 31,85 [16]	-	-	-
Serienschalter 10 AX 	-	752155 ⁽¹⁾⁽²⁾ € 27,95 [16]	-	-	-
Doppelwechselschalter 10 AX 	-	752158 ⁽¹⁾⁽²⁾ € 27,95 [16]	-	-	-
Doppelwechselschalter 10 AX, beleuchtet 	-	752159 ⁽¹⁾⁽²⁾ € 35,95 [16]	-	-	-
Ausschalter 2-polig, 10 AX 	-	752164 ⁽¹⁾⁽²⁾ € 35,75 [16]	-	-	-
FEUCHTRAUM-TASTER IP 44					
Wechseltaster 	-	752171 ⁽¹⁾⁽²⁾ € 24,25 [16]	-	-	-
Wechseltaster mit Glockensymbol 	-	752175 ⁽¹⁾⁽²⁾ € 24,05 [16]	-	-	-
Wechseltaster, beleuchtet, mit Glockensymbol 	-	752176 ⁽¹⁾⁽²⁾ € 24,05 [16]	-	-	-
FEUCHTRAUM-STECKDOSE IP 44					
Schutzkontakt-Steckdose IP 44 	-	753119 ⁽¹⁾⁽²⁾ € 21,35 [16]	-	-	-







1: inkl. Einsatz

2: Für die IP 44-Einsätze werden die Standard-Abdeckrahmen zur Komplettierung verwendet.

Valena™ Life

Auswahltabelle für Wippen und Abdeckungen

Funktion	VALENA IN'MATIC EINSATZ	VALENA LIFE ABDECKUNGEN			
		Ultraweiß 	Mandelweiß 	Aluminium 	Schwarz 
FEUCHTRAUM-BEWEGUNGSMELDER IP 44					
Bewegungsmelder IP 44, 120° 	-	752177 ⁽¹⁾⁽³⁾ € 148,00 [15]	-	-	-
FEUCHTRAUMABDECKUNG IP 44					
Abdeckung mit Klappdeckel 	-	754021 ⁽⁴⁾ € 14,25 [16]	-	-	-

Funktion	MOSAIC EINSATZ	MOSAIC ADAPTER VALENA LIFE			
		Ultraweiß 	Mandelweiß 	Aluminium 	Schwarz 
MOSAIC BEWEGUNGSMELDER ZUM EINBAU IN VALENA LIFE					
Mosaic Bewegungsmelder 3L 2000W Dualtech, 120° 	078452 ⁽¹⁾ € 134,20 [29]	752144 ⁽¹⁾ € 5,96 [16]	-	-	-
Mosaic Bewegungsmelder 3L 2000W, 120° 	078454 ⁽¹⁾ € 164,55 [29]	752144 ⁽¹⁾ € 5,96 [16]	-	-	-
IR-Fernbedienung Komfort DLM 	-	BMS04001 ⁽²⁾ € 151,30 [56]			

1: Einsatz inkl. Wippe in Ultraweiß

2: Farbe: Weiß

3: Für die IP 44-Einsätze werden die Standard-Abdeckrahmen zur Komplettierung verwendet.

4: Für den Einbau von Standard-Einsätzen zur Erhöhung auf Schutzart IP 44. (Einbauhöhe der Einsätze beachten.)

Valena™ Life / Allure



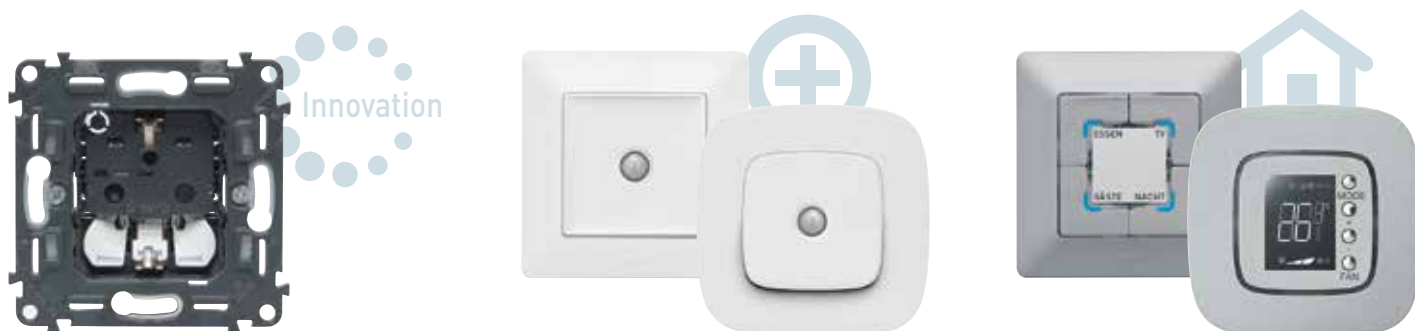

















Valena™ Life und Valena™ Allure – die Schalter bieten neben vorbildlichem Design auch neue Perspektiven in der Hausautomation. Sie werden zu kleinen elektronischen Systemlösungen. Gerade in Verbindung mit MyHOME machen sie das Leben komfortabler, sicherer und wirtschaftlicher. Die Valena Schalterserie verfügt über mehr als 150 Funktionen. So kann mittels Funkübertragung eine Anwendung einfach in die herkömmliche Elektrostruktur integriert werden.



Valena™ Life

Auswahltabelle Abdeckrahmen

Die gleiche Bestellnummer ist sowohl für die vertikale als auch für die horizontale Ausrichtung verwendbar.

VALENA LIFE									
ABDECKRAHMEN (für horizontale und vertikale Montage)		1-FACH	2-FACH	3-FACH	4-FACH	5-FACH	5 Module	Spezielle Abdeckrahmen für Doppelsteckdosen	
								1-FACH	2-FACH
Ultraweiß		754001 € 3,07 [13]	754002 € 5,23 [13]	754003 € 8,79 [13]	754004 € 15,00 [13]	754005 € 24,60 [16]	754006 € 8,79 [16]	754221 € 5,23 [16]	754222 € 9,73 [16]
Ultraweiß mit Beschriftungsfeld ⁽¹⁾		754011 € 6,13 [16]	754012 € 10,45 [16]	754013 € 17,50 [16]					
Ultraweiß IP 44 mit Klappdeckel ⁽²⁾		754021 € 14,25 [16]							
Ultraweiß/Chrom		754031 € 4,59 [16]	754032 € 7,85 [16]	754033 € 13,15 [16]	754034 € 22,40 [16]	754035 € 36,80 [16]			
Schwarz		754251 € 4,59 [16]	754252 € 7,85 [16]	754253 € 13,15 [16]	754254 € 22,40 [16]	754255 € 36,80 [16]		754261 € 5,23 [16]	
Mandelweiß		754041 € 3,07 [13]	754042 € 5,23 [13]	754043 € 8,79 [13]	754044 € 15,00 [13]	754045 € 24,60 [16]	754046 € 8,79 [16]	754231 € 5,23 [16]	754232 € 9,73 [16]
Mandelweiß mit Beschriftungsfeld ⁽¹⁾		754051 € 6,13 [16]	754052 € 10,45 [16]	754053 € 17,50 [16]					
Mandelweiß/Gold		754061 € 4,59 [16]	754062 € 7,85 [16]	754063 € 13,15 [16]	754064 € 22,40 [16]	754065 € 36,80 [16]			
Terracotta		754071 € 3,07 [16]	754072 € 5,23 [16]	754073 € 8,79 [16]	754074 € 15,00 [16]	754075 € 24,60 [16]			
Limone		754081 € 3,07 [16]	754082 € 5,23 [16]	754083 € 8,79 [16]	754084 € 15,00 [16]	754085 € 24,60 [16]			
Adria		754091 € 3,07 [16]	754092 € 5,23 [16]	754093 € 8,79 [16]	754094 € 15,00 [16]	754095 € 24,60 [16]			
Aluminium		754131 € 4,59 [16]	754132 € 7,85 [16]	754133 € 13,15 [16]	754134 € 22,40 [16]	754135 € 36,80 [16]	754136 € 13,15 [16]	754241 € 5,23 [16]	754242 € 9,73 [16]
Perlmutter		754141 € 4,59 [16]	754142 € 7,85 [16]	754143 € 13,15 [16]	754144 € 22,40 [16]	754145 € 36,80 [16]			
Inoxgrau		754151 € 5,52 [16]	754152 € 9,42 [16]	754153 € 15,85 [16]	754154 € 26,80 [16]	754155 € 44,05 [16]			
Graphit (NEU!)		754271 € 4,59 [16]	754272 € 7,85 [16]	754273 € 13,15 [16]	754274 € 22,40 [16]	754275 € 36,80 [16]			











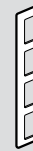

1: Rahmen mit Beschriftungsfeld sind nur für die horizontale Montage geeignet

2: Für den Einbau von Standard-Einsätzen zur Erhöhung auf Schutzart IP 44. (Einbauhöhe der Einsätze beachten.)

Valena™ Life

Auswahltabelle Abdeckrahmen

Die gleiche Bestellnummer ist sowohl für die vertikale als auch für die horizontale Ausrichtung verwendbar.

VALENA LIFE									
ABDECKRAHMEN (für horizontale und vertikale Montage)		1-FACH	2-FACH	3-FACH	4-FACH	5-FACH	5 Module	Spezielle Abdeckrahmen für Doppelsteckdosen	
								1-FACH	2-FACH
Kupfer		754161 € 5,52 [16]	754162 € 9,42 [16]	754163 € 15,85 [16]	754164 € 26,80 [16]	754165 € 44,05 [16]			
Dark Wood		754171 € 5,52 [16]	754172 € 9,42 [16]	754173 € 15,85 [16]	754174 € 26,80 [16]	754175 € 44,05 [16]			
Light Wood		754181 € 5,52 [16]	754182 € 9,42 [16]	754183 € 15,85 [16]	754184 € 26,80 [16]	754185 € 44,05 [16]			
AUFPUTZGEHÄUSE									
Aufputzgehäuse Ultraweiß		754191 € 11,80 [16]	754192 € 21,50 [16]						
Aufputzgehäuse Mandelweiß		754201 € 11,80 [16]	754202 € 21,50 [16]						
Aufputzgehäuse Aluminium		754211 € 11,80 [16]	754212 € 21,50 [16]						
Aufputzgehäuse Schwarz		754066 € 11,80 [16]	754067 € 21,50 [16]						

Valena™ Life

Abmessungen der Abdeckrahmen

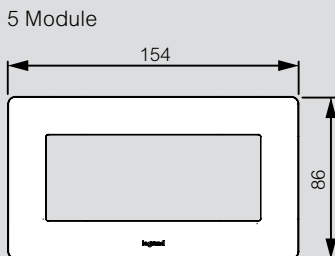
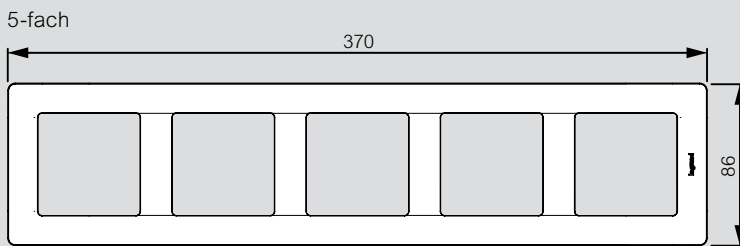
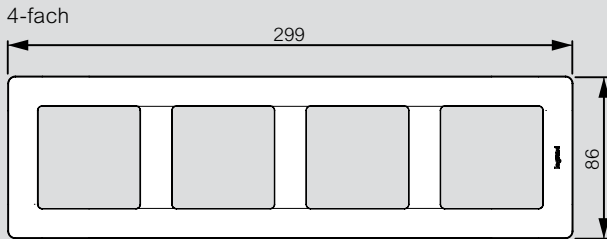
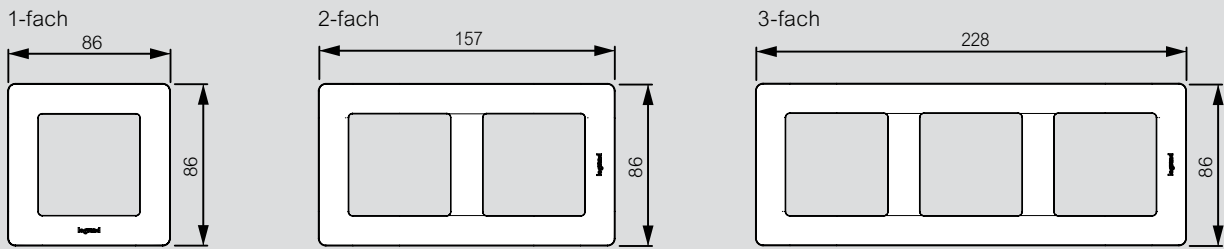

Spezielle Abdeckrahmen für Doppelsteckdosen

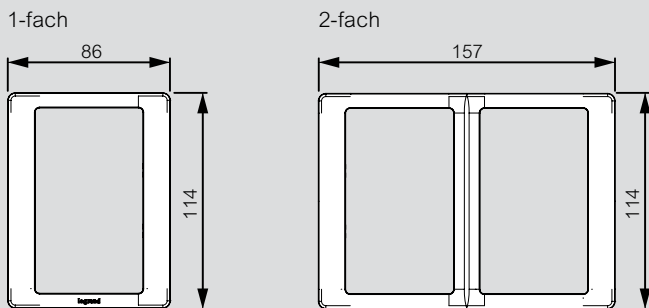

VALENA™ **ALLURE**

KÜHNHEIT

KURVEN















LEICHTIGKEIT

REVOLUTION

VERÄNDERN SIE **IHRE WAHRNEHMUNG**



Machen Sie mit der Valena Allure-Kollektion den ersten Schritt heraus aus dem Herkömmlichen. Entdecken Sie, wie faszinierend gutes Design ihr Heim in eine Arena von neuen Erfahrungen verwandelt. Die Reihe von atemberaubenden Ausführungen und Materialien lädt Sie ein, Ihrer Ausdruckskraft freien Lauf zu lassen.















Funktion	VALENA IN'MATIC EINSATZ	VALENA ALLURE ABDECKUNGEN				
		Ultraweiß	Mandelweiß	Aluminium	Mattschwarz	Perlmutter
SCHALTER 10 AX – 250 V~						
Wechselschalter 	752006 € 9,79 [13]					
Wechselschalter mit N-Klemme 	752010 € 20,85 [14]	755005 € 7,61 [17]	755006 € 7,61 [17]	755007 € 9,81 [17]	755008 € 9,81 [17]	755009 € 9,81 [17]
Kontroll-Wechselschalter mit N-Klemme 	752010 + 752058 ⁽²⁾ € 20,85 + € 9,26 [14] [14]					
	752010 + 067688 € 20,85 + € 6,70 [14] [29]	755085 ⁽¹⁾ € 9,15 [17]	755086 ⁽¹⁾ € 9,15 [17]	755087 ⁽¹⁾ € 10,70 [17]	755088 ⁽¹⁾ € 10,70 [17]	755089 ⁽¹⁾ € 10,70 [17]
Kreuzschalter 	752007 € 19,75 [14]	755005 € 7,61 [17]	755006 € 7,61 [17]	755007 € 9,81 [17]	755008 € 9,81 [17]	755009 € 9,81 [17]
Wechselschalter, beleuchtet 	752006 + 752057 ⁽²⁾ € 9,79 + € 9,26 [13] [14]	755005 € 7,61 [17]	755006 € 7,61 [17]	755007 € 9,81 [17]	755008 € 9,81 [17]	755009 € 9,81 [17]
	752006 + 067686 € 9,79 + € 6,70 [13] [14]	755085 ⁽¹⁾ € 9,15 [17]	755086 ⁽¹⁾ € 9,15 [17]	755087 ⁽¹⁾ € 10,70 [17]	755088 ⁽¹⁾ € 10,70 [17]	755089 ⁽¹⁾ € 10,70 [17]
Kreuzschalter, beleuchtet 	752007 + 665090 € 19,75 + € 4,52 [14] [26]	755085 € 9,15 [17]	755086 € 9,15 [17]	755087 € 10,70 [17]	755088 € 10,70 [17]	755089 € 10,70 [17]
Serienschalter 	752005 € 15,25 [13]					
Doppelwechselschalter 	752008 € 25,95 [14]	755025 € 10,05 [17]	755026 € 10,05 [17]	755027 € 11,85 [17]	755028 € 11,85 [17]	755029 € 11,85 [17]
	752005 + 2 x 067684 € 15,25 + 2 x € 4,38 [13] [14]	755225 ⁽¹⁾ € 11,80 [17]	755226 ⁽¹⁾ € 11,80 [17]	755227 ⁽¹⁾ € 13,30 [17]	755228 ⁽¹⁾ € 13,30 [17]	755229 ⁽¹⁾ € 13,30 [17]
Serienschalter, beleuchtet 	752005 + 2 x 665091 € 15,25 + 2 x € 4,52 [13] [26]					
Serienschalter Kontroll 	752005 + 2 x 665091 € 15,25 + 2 x € 4,52 [13] [26]					
Doppelwechselschalter, beleuchtet 	752008 + 2 x 752057 ⁽²⁾ € 25,95 + 2 x € 9,26 [14] [14]	755025 € 10,05 [17]	755026 € 10,05 [17]	755027 € 11,85 [17]	755028 € 11,85 [17]	755029 € 11,85 [17]
	752008 + 2 x 067686 € 25,95 + 2 x € 6,70 [14] [14]	755225 ⁽¹⁾ € 11,80 [17]	755226 ⁽¹⁾ € 11,80 [17]	755227 ⁽¹⁾ € 13,30 [17]	755228 ⁽¹⁾ € 13,30 [17]	755229 ⁽¹⁾ € 13,30 [17]
3-fach Ausschalter 	752003 € 27,95 [14]	755035 € 12,40 [17]	755036 € 12,40 [17]	755037 € 13,75 [17]	755038 € 13,75 [17]	755039 € 13,75 [17]
2-poliger Ausschalter 	752004 € 20,10 [14]	755125 € 8,15 [17]	755126 € 8,15 [17]	755127 € 9,37 [17]	755128 € 9,37 [17]	755129 € 9,37 [17]
2-poliger Ausschalter Kontroll 	752042 ⁽¹⁾ € 32,60 [14]	755045 € 9,97 [17]	755046 € 9,97 [17]	755047 € 11,60 [17]	755048 € 11,60 [17]	755049 € 11,60 [17]

1: Wippe mit blauem Beleuchtungsfenster



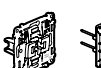

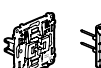

2: Spezielle LED zur seitlichen Beleuchtung der Standardwippen

Valena™ Allure

Auswahltabelle für Wippen und Abdeckungen

Funktion	VALENA IN'MATIC EINSATZ	VALENA ALLURE ABDECKUNGEN				
		Ultraweiß 	Mandelweiß 	Aluminium 	Mattschwarz 	Perlmutter 
SCHALTER 16 AX – 250 V~						
Wechselschalter 	752027 € 35,75 [14]	755005 € 7,61 [17]	755006 € 7,61 [17]	755007 € 9,81 [17]	755008 € 9,81 [17]	755009 € 9,81 [17]
TASTER 6 A/10 A – 250 V~ und 6 A – 12 V~						
Wechseltaster 6 A 	752011 € 11,10 [13]	755005 € 7,61 [17]	755006 € 7,61 [17]	755007 € 9,81 [17]	755008 € 9,81 [17]	755009 € 9,81 [17]
Wechseltaster 10 A 	752012 € 11,10 [14]					
Wechseltaster 6 A mit Glockensymbol 	752011 € 11,10 [13]	755015 € 8,09 [17]	755016 € 8,09 [17]	755017 € 9,19 [17]	755018 € 9,19 [17]	755019 € 9,19 [17]
Wechseltaster 10 A mit Glockensymbol 	752012 € 11,10 [14]					
Wechseltaster 6 A, beleuchtet 	752011 + 752057 ⁽²⁾ € 11,10 + € 9,26 [13] [14] 752011 + 067686 € 11,10 + € 6,70 [13] [14]	755085 ⁽³⁾ € 9,15 [17]	755086 ⁽³⁾ € 9,15 [17]	755087 ⁽³⁾ € 10,70 [17]	755088 ⁽³⁾ € 10,70 [17]	755089 ⁽³⁾ € 10,70 [17]
Wechseltaster 10 A, beleuchtet 	752012 + 752057 ⁽²⁾ € 11,10 + € 9,26 [14] [14] 752012 + 067686 € 11,10 + € 6,70 [14] [14]					
Wechseltaster 6 A, beleuchtet mit Glockensymbol 	752011 + 752057 ⁽²⁾ € 11,10 + € 9,26 [13] [14] 752011 + 067686 € 11,10 + € 6,70 [13] [14]	755090 ⁽³⁾ € 9,99 [17]	755091 ⁽³⁾ € 9,99 [17]	755092 ⁽³⁾ € 11,60 [17]	755093 ⁽³⁾ € 11,60 [17]	755094 ⁽³⁾ € 11,60 [17]
Wechseltaster 10 A, beleuchtet mit Glockensymbol 	752012 + 752057 ⁽²⁾ € 11,10 + € 9,26 [14] [14] 752012 + 067686 € 11,10 + € 6,70 [14] [14]					

1: LED Best.Nr. 665091 enthalten
 2: Spezielle LED zur seitlichen Beleuchtung der Standardwippen
 3: Wippe mit blauem Beleuchtungsfenster

Funktion	VALENA IN'MATIC EINSATZ	VALENA ALLURE ABDECKUNGEN				
		Ultraweiß	Mandelweiß	Aluminium	Mattschwarz	Perlmutter
TASTER 6 A/10 A – 250 V~ und 6 A – 12 V~						
Wechseltaster 6 A, beleuchtet, mit Beschriftungsfeld 	752011 + 752057 ⁽²⁾ € 11,10 + € 9,26 [13] [14]					
	752011 + 067686 € 11,10 + € 6,70 [13] [14]					
Wechseltaster 10 A, beleuchtet, mit Beschriftungsfeld 	752012 + 752057 ⁽²⁾ € 11,10 + € 9,26 [14] [14]					
	752012 + 067686 € 11,10 + € 6,70 [14] [14]					
Doppelwechseltaster 6 A 	752018 € 26,55 [14]	755025 € 10,05 [17]	755026 € 10,05 [17]	755027 € 11,85 [17]	755028 € 11,85 [17]	755029 € 11,85 [17]
Doppelwechseltaster 6 A, beleuchtet 	752018 + 2 x 752057 ⁽²⁾ € 26,55 + 2 x € 9,26 [14] [14]	755225 ⁽¹⁾ € 11,80 [17]	755226 ⁽¹⁾ € 11,80 [17]	755227 ⁽¹⁾ € 13,30 [17]	755228 ⁽¹⁾ € 13,30 [17]	755229 ⁽¹⁾ € 13,30 [17]
	752018 + 2 x 067686 € 26,55 + 2 x € 6,70 [14] [14]					
Taster 6 A, beleuchtet, 12 V~ 	752013 € 15,45 [14]	755085 ⁽¹⁾ € 9,15 [17]	755086 ⁽¹⁾ € 9,15 [17]	755087 ⁽¹⁾ € 10,70 [17]	755088 ⁽¹⁾ € 10,70 [17]	755089 ⁽¹⁾ € 10,70 [17]
DREH- UND SCHLÜSSELSCHALTER						
3-Stufenschalter, mit Nullstellung (0, 1, 2, 3) 	-	755175 ⁽⁴⁾ € 97,10 [17]	755176 ⁽⁴⁾ € 97,10 [17]	755177 ⁽⁴⁾ € 101,55 [17]	755178 ⁽⁴⁾ € 101,55 [17]	755179 ⁽⁴⁾ € 101,55 [17]
Schlüsselschalter DIN, für DIN-Halbprofilzylinder (0, 1) (nicht enthalten) in allen Stellungen abziehbar 	-	755235 ⁽⁴⁾ € 92,70 [17]	-	-	-	-

1: Wippe mit blauem Beleuchtungsfenster









2: Spezielle LED zur seitlichen Beleuchtung der Standardwippen

3: Transparente Wippe mit 3 unterschiedlichen Einlagen (Ultraweiß, Mandelweiß, Aluminium)

4: inkl. Einsatz

Valena™ Allure

Auswahltabelle für Wippen und Abdeckungen

Funktion	VALENA IN'MATIC EINSATZ	VALENA ALLURE ABDECKUNGEN				
		Ultraweiß	Mandelweiß	Aluminium	Mattschwarz	Perlmutter
ROLLADENSTEUERUNG						
Rollladen-/Jalousieschalter 	752029 € 26,15 [14]	755145 € 14,35 [17]	755146 € 14,35 [17]	755147 € 16,65 [17]	755148 € 16,65 [17]	755149 € 16,65 [17]
Rollladen-/Jalousietaster 	752020 € 26,15 [14]					
DIMMER						
LED-Universal-Drehdimmer, 300 W ohne Neutralleiter, Phasen-/abschnitt 	752060 € 50,90 [15]	752045 € 15,35 [17]	752046 € 15,35 [17]	752047 € 19,90 [17]	752048 € 19,90 [17]	752049 € 19,90 [17]
LED-Universal-Tastdimmer, 400 W ohne Neutralleiter, Phasen-/abschnitt 	752062 € 118,05 [15]	752085 € 16,20 [17]	752086 € 16,20 [17]	752087 € 21,15 [17]	752088 € 21,15 [17]	752089 € 21,15 [17]
Tastdimmer 1 – 10 V, Steuerstrom 40 mA DC, Schaltleistung max. 600 VA 	752067 € 64,35 [15]					
BEWEGUNGSMELDER						
Bewegungsmelder 2-Leiter, 120°, 250 W ⁽²⁾ 	752070 € 125,80 [15]	752179 € 16,00 [17]	752279 € 16,00 [17]	752379 € 17,20 [17]	-	-
Bewegungsmelder 3-Leiter, 120°, 400 W ⁽³⁾ 	752073 € 44,75 [15]					
Bewegungsmelder 2-Leiter mit Handschalter, 120°, 250 W ⁽²⁾ 	752070 € 125,80 [15]	752180 € 17,20 [17]	752280 € 17,20 [17]	752380 € 19,75 [17]	752181 € 19,75 [17]	752281 € 19,75 [17]

1: inkl. Einsatz

2: Für folgende Lastarten geeignet:

- Glüh- und HV-Halogenlampen: 3 - 250 W

- LEDs, Leuchtstoff- und Kompaktleuchtstofflampen und NV-Halogenlampen mit elektronischem oder konventionellem Vorschaltgerät: 3 - 250 VA

- LED- oder Kompaktleuchtstofflampen: 3 - 100 W, Parallelschaltung mehrerer Bewegungsmelder möglich, (max. 2 zusätzliche Sensoren).

Die Einstellungen werden mittels Potentiometer durchgeführt.

















3: Für folgende Lastarten geeignet:

- Glüh- und HV-Halogenlampen: bis 400 W

- LEDs, Leuchtstoff- und Kompaktleuchtstofflampen und NV-Halogenlampen mit elektronischem oder konventionellem Vorschaltgerät: bis 200 VA

- LED- oder Kompaktleuchtstofflampen: bis 50 W, Parallelschaltung mehrerer Bewegungsmelder möglich.

















Die Einstellungen werden mittels Potentiometer durchgeführt.

Funktion	VALENA IN'MATIC EINSATZ	VALENA ALLURE ABDECKUNGEN				
		Ultraweiß 	Mandelweiß 	Aluminium 	Mattschwarz 	Perlmutter 
ZEIT-/NACHLAUFSCHALTER						
Nachlaufschalter 	752032 € 170,30 [14]	755215 € 9,15 [17]	755216 € 9,15 [17]	755217 € 10,70 [17]	755218 € 10,70 [17]	755219 € 10,70 [17]
Zeitschalter elektronisch 	752061 € 118,05 [15]					
KARTENSCHALTER						
Hotel-Card-Schalter 	752025 € 41,05 [14]	755160 € 29,15 [16]	755161 € 29,15 [16]	755162 € 29,15 [16]	755168 € 36,30 [17]	755169 € 36,30 [17]
THERMOSTATE						
Elektronischer Raumthermostat 	752033 € 112,00 [15]	755315 € 7,33 [17]	755316 € 7,33 [17]	755317 € 11,15 [17]	755318 € 11,15 [17]	755319 € 11,15 [17]
Fussboden-Raumthermostat 	752034 € 216,50 [15]	755325 € 7,33 [17]	755326 € 7,33 [17]	755327 € 11,15 [17]	755328 € 11,15 [17]	755329 € 11,15 [17]
BESCHALLUNG						
Bluetooth-Modul 	752036 € 167,50 [15]	755435 € 17,20 [17]	755436 € 17,20 [17]	755437 € 21,70 [17]	755438 € 21,70 [17]	755439 € 21,70 [17]
STECKDOSEN 16 A MIT STECKKLEMMEN UND ERHÖHTEM BERÜHRUNGSSCHUTZ						
Steckdose 	-	754885 ⁽¹⁾ € 9,87 [17]	754886 ⁽¹⁾ € 9,87 [17]	754887 ⁽¹⁾ € 13,15 [17]	754888 ⁽¹⁾ € 13,15 [17]	754889 ⁽¹⁾ € 13,15 [17]
Steckdose mit Klappdeckel 	-	755155 ⁽¹⁾ € 17,65 [17]	-	-	-	-
Kombinationssteckdose mit USB-C, 1500 mA (für 1-fach Rahmen) 	-	753005 ⁽¹⁾ € 66,55 [15]	753006 ⁽¹⁾ € 66,55 [15]	753007 ⁽¹⁾ € 66,55 [15]	-	-
Steckdose, verwechslungssicher 	-	753132 (Farbe Rot) ⁽¹⁾ € 33,80 [17]				
Steckdose mit Kontrollfunktion 	754885 € 9,87 [17]	754855 + 067664 € 4,34 + € 8,67 [17] [14]	754856 + 067664 € 4,34 + € 8,67 [17] [14]	754857 + 067664 € 6,56 + € 8,67 [17] [14]	754858 + 067664 € 6,56 + € 8,67 [17] [14]	754859 + 067664 € 6,56 + € 8,67 [17] [14]















1: inkl. Einsatz

Valena™ Allure

Auswahltabelle für Wippen und Abdeckungen









Funktion	VALENA IN'MATIC EINSATZ	VALENA ALLURE ABDECKUNGEN				
		Ultraweiß 	Mandelweiß 	Aluminium 	Mattschwarz 	Perlmutter 
ZUBEHÖR						
Kabelaussch mit Klemmen 	753033 € 12,50 [14]	755055 € 8,80 [17]	755056 € 8,80 [17]	755057 € 9,42 [17]	-	-
Kabelaussch ohne Klemmen 	753034 € 10,25 [14]					
TV-R-SAT-DOSEN						
TV-R-SAT Durchgangsdose, System Legrand 	753065 € 25,85 [14]	754795 € 10,95 [17]	754796 € 10,95 [17]	754797 € 12,25 [17]	754798 € 12,25 [17]	754799 € 12,25 [17]
TV-R-SAT Enddose, System Legrand 	753064 € 25,85 [14]					
TV-R-SAT Einzeldose, System Hirschmann 	775983 € 31,65 [21]	754805 € 9,77 [17]	754806 € 9,77 [17]	754807 € 11,10 [17]	754808 € 11,10 [17]	754809 € 11,10 [17]
TV-R-DOSEN						
TV-R Einzeldose, System Hirschmann 	775981 € 26,45 [21]	754805 € 9,77 [17]	754806 € 9,77 [17]	754807 € 11,10 [17]	754808 € 11,10 [17]	754809 € 11,10 [17]
TV-R Durchgangsdose, System Hirschmann 	775984 € 29,05 [21]					
TV-R-SAT-SAT-DOSE						
TV-R-SAT-SAT	753056 € 25,30 [14]	754815 € 10,95 [17]	754816 € 10,95 [17]	754817 € 12,25 [17]	754818 € 12,25 [17]	-
EINZELDOSE TV + RJ45						
TV-DOSE 0–2400 MHz + RJ45, Kategorie 6, UTP 	753055 € 37,25 [14]	754835 € 8,80 [17]	754836 € 8,80 [17]	754837 € 11,50 [17]	754838 € 11,50 [17]	754839 € 11,50 [17]
DATENDOSEN KATEGORIE 6 UND KATEGORIE 6 A						
RJ45-Datendose, Kat. 6, UTP 	753042 € 22,20 [14]	755415 € 7,92 [17] oder 755475 € 11,55 [17]	755416 € 7,92 [17] oder 755476 € 11,55 [17]	755417 € 10,25 [17] oder 755477 € 13,30 [17]	755418 € 10,25 [17] oder 755478 € 13,30 [17]	755419 € 10,25 [17] oder 755479 € 13,30 [17]
RJ45-Datendose, Kat. 6 A, UTP 	753044 € 24,85 [14]					
RJ45-Datendose, Kat. 6, STP 	753046 € 27,25 [14]	(mit Beschriftungsfeld)	(mit Beschriftungsfeld)	(mit Beschriftungsfeld)	(mit Beschriftungsfeld)	(mit Beschriftungsfeld)
RJ45-Datendose, Kat. 6 A, STP 	753048 € 30,15 [14]					

1: inkl. Einsatz

Funktion	VALENA IN'MATIC EINSATZ	VALENA ALLURE ABDECKUNGEN				
		Ultraweiß 	Mandelweiß 	Aluminium 	Mattschwarz 	Perlmutter 
DATENDOSEN KATEGORIE 6 UND KATEGORIE 6 A						
2 x RJ45-Datendose, Kat. 6, UTP	 753043 € 30,50 [14]					
2 x RJ45-Datendose, Kat. 6 A, UTP	 753045 € 34,05 [13]	755425 € 8,81 [17]	755426 € 8,81 [17]	755427 € 11,50 [17]	755428 € 11,50 [17]	755429 € 11,50 [17]
2 x RJ45-Datendose, Kat. 6, STP	 753047 € 36,55 [14]	oder 755485 € 11,55 [17]	oder 755486 € 11,55 [17]	oder 755487 € 13,30 [17]	oder 755488 € 13,30 [17]	oder 755489 € 13,30 [17]
2 x RJ45-Datendose, Kat. 6 A, STP	 753049 € 40,95 [13]	(mit Beschriftungsfeld)	(mit Beschriftungsfeld)	(mit Beschriftungsfeld)	(mit Beschriftungsfeld)	(mit Beschriftungsfeld)
Kombidose RJ11 + RJ45, Kat.6, UTP	 753032 € 32,05 [14]					
TELEFONDOSEN						
RJ11 Telefondose	 753038 € 21,50 [14]	755415 € 7,92 [17] oder 755475 € 11,55 [17] (mit Beschriftungsfeld)	755416 € 7,92 [17] oder 755476 € 11,55 [17] (mit Beschriftungsfeld)	755417 € 10,25 [17] oder 755477 € 13,30 [17] (mit Beschriftungsfeld)	755418 € 10,25 [17] oder 755478 € 13,30 [17] (mit Beschriftungsfeld)	755419 € 10,25 [17] oder 755479 € 13,30 [17] (mit Beschriftungsfeld)
2 x RJ11 Telefondose	 753039 € 23,95 [14]	755425 € 8,81 [17] oder 755485 € 11,55 [17] (mit Beschriftungsfeld)	755426 € 8,81 [17] oder 755486 € 11,55 [17] (mit Beschriftungsfeld)	755427 € 11,50 [17] oder 755487 € 13,30 [17] (mit Beschriftungsfeld)	755428 € 11,50 [17] oder 755488 € 13,30 [17] (mit Beschriftungsfeld)	755429 € 11,50 [17] oder 755489 € 13,30 [17] (mit Beschriftungsfeld)
TAE / TDO Telefondose	 775991 € 14,85 [21] 775990 € 48,75 [21]	755495 € 9,19 [17]	755496 € 9,19 [17]	755497 € 10,55 [17]	755498 € 10,55 [17]	755499 € 10,55 [17]
LAUTSPRECHER-ANSCHLUSSDOSEN						
Lautsprecherdose mit Federklemmen	 753072 € 16,65 [14]	755365 € 11,85 [17]	755366 € 11,85 [17]	755367 € 13,70 [17]	-	-
Lautsprecherdose mit Federklemmen, 2-fach	 753078 € 21,00 [14]	755375 € 12,35 [17]	755376 € 12,35 [17]	755377 € 14,30 [16]	-	-

Valena™ Allure

Auswahltabelle für Wippen und Abdeckungen

















Funktion	VALENA IN'MATIC EINSATZ	VALENA ALLURE ABDECKUNGEN				
		Ultraweiß	Mandelweiß	Aluminium	Mattschwarz	Perlmutter
<div style="display: flex; justify-content: space-around; align-items: center;"> ○ ○ ○ ● ○ </div>						
AUDIO- UND VIDEOANSCHLUSSDOSEN						
RCA-Dose, 3-fach 	753075 € 56,00 [14]	754725 € 12,35 [17]	754726 € 12,35 [17]	754727 € 14,30 [17]	-	-
USB-Dose mit Kabel 	753082 € 81,35 [15]	754755 € 10,50 [17]	-	754757 € 16,35 [17]	-	-
USB-LADESTECKDOSEN						
Typ A+C USB-Ladedose, 2-fach, 3000 mA 	-	754965 ⁽¹⁾ € 49,30 [15]	754966 ⁽¹⁾ € 49,30 [15]	754967 ⁽¹⁾ € 49,30 [15]	-	-
Typ C USB-Ladedose, 2-fach, 3000 mA 	-	755345 ⁽¹⁾ € 57,70 [15]	755346 ⁽¹⁾ € 57,70 [15]	755347 ⁽¹⁾ € 57,70 [15]	-	-
Typ A USB-Ladedose, 2-fach, 3000 mA 	-	754995 ⁽¹⁾ € 49,35 [15]	754996 ⁽¹⁾ € 49,35 [15]	754997 ⁽¹⁾ € 54,55 [15]	754998 ⁽¹⁾ € 54,55 [15]	754999 ⁽¹⁾ € 54,55 [15]
WIRELESS CHARGING FÜR UNTERPUTZ-DOSEN						
Wireless Charging 1000 mA Wireless Charging 2400 mA USB Typ A 	-	755114 ⁽¹⁾⁽²⁾ € 108,30 [15]				
ZUBEHÖR						
Aufputzgehäuse, 1-fach 	-	755551 € 13,70 [17]	755561 € 13,70 [17]	755571 € 17,00 [17]	-	-
Aufputzgehäuse, 2-fach 	-	755552 € 26,95 [17]	755562 € 26,95 [17]	755572 € 32,75 [17]	-	-
Blindabdeckung 	-	755185 € 13,55 [17]	755186 € 13,55 [17]	755187 € 18,20 [17]	-	-

1: inkl. Einsatz

2: wird in den Farben Schwarz / Aluminium geliefert

Valena™ Allure

Auswahltabelle Abdeckrahmen (Lieferzeit auf Anfrage¹)

		VALENA ALLURE					
ABDECKRAHMEN (für horizontale und vertikale Montage)		1-FACH	2-FACH	3-FACH	4-FACH	5-FACH	5 MODULE
							
Ultraweiß		754301 € 5,52 [17]	754302 € 9,34 [17]	754303 € 16,20 [17]	754304 € 24,35 [17]	754305 € 34,75 [17]	754306 € 16,20 [17]
Mandelweiß		754311 € 5,52 [17]	754312 € 9,34 [17]	754313 € 16,20 [17]	754314 € 24,35 [17]	754315 € 34,75 [17]	754316 € 16,20 [17]
Chromestyle		754341 € 15,45 [17]	754342 € 26,15 [17]	754343 € 45,20 [17]	754344 € 68,20 [17]	754345 € 97,40 [17]	
Goldstyle		754351 € 15,45 [17]	754352 € 26,15 [17]	754353 € 45,20 [17]	754354 € 68,20 [17]	754355 € 97,40 [17]	
Aluminium		754391 € 7,15 [17]	754392 € 12,15 [17]	754393 € 20,85 [17]	754394 € 31,65 [17]	754395 € 45,40 [17]	754396 € 20,85 [17]
Mattschwarz		754401 € 7,15 [17]	754402 € 12,15 [17]	754403 € 20,85 [17]	754404 € 31,65 [17]	754405 € 45,40 [17]	754406 € 20,85 [17]
Perlmutter		754411 € 7,15 [17]	754412 € 12,15 [17]	754413 € 20,85 [17]	754414 € 31,65 [17]	754415 € 45,40 [17]	754416 € 20,85 [17]
White Mirror		754421 € 34,40 [17]	754422 € 52,25 [17]	754423 € 94,10 [17]	754424 € 124,00 [17]	754425 € 154,45 [17]	
Leder⁽¹⁾		754451 € 34,40 [17]	754452 € 52,25 [17]	754453 € 94,10 [17]	754454 € 124,00 [17]	754455 € 154,45 [17]	
Walnuss⁽¹⁾		754461 € 34,40 [17]	754462 € 52,25 [17]	754463 € 94,10 [17]	754464 € 124,00 [17]	754465 € 154,45 [17]	

1: Lieferzeit auf Anfrage

Valena™ Allure

Auswahltabelle Abdeckrahmen (Lieferzeit auf Anfrage¹)

VALENA ALLURE							
ABDECKRAHMEN (für horizontale und vertikale Montage)		1-FACH	2-FACH	3-FACH	4-FACH	5-FACH	5 MODULE
Marmor⁽¹⁾		755521 € 61,10 [17]	755522 € 112,00 [17]	755523 € 157,40 [17]			
White Glass⁽¹⁾		755541 € 61,10 [17]	755542 € 112,00 [17]	755543 € 157,40 [17]	755544 € 194,90 [17]	755545 € 239,65 [17]	
AUFPUTZGEHÄUSE							
Aufputzgehäuse Ultraweiß		755551 € 13,70 [17]	755552 € 26,95 [17]				
Aufputzgehäuse Mandelweiß		755561 € 13,70 [17]	755562 € 26,95 [17]				
Aufputzgehäuse Aluminium		755571 € 17,00 [17]	755572 € 32,75 [17]				

1: Lieferzeit auf Anfrage

Valena™ Allure



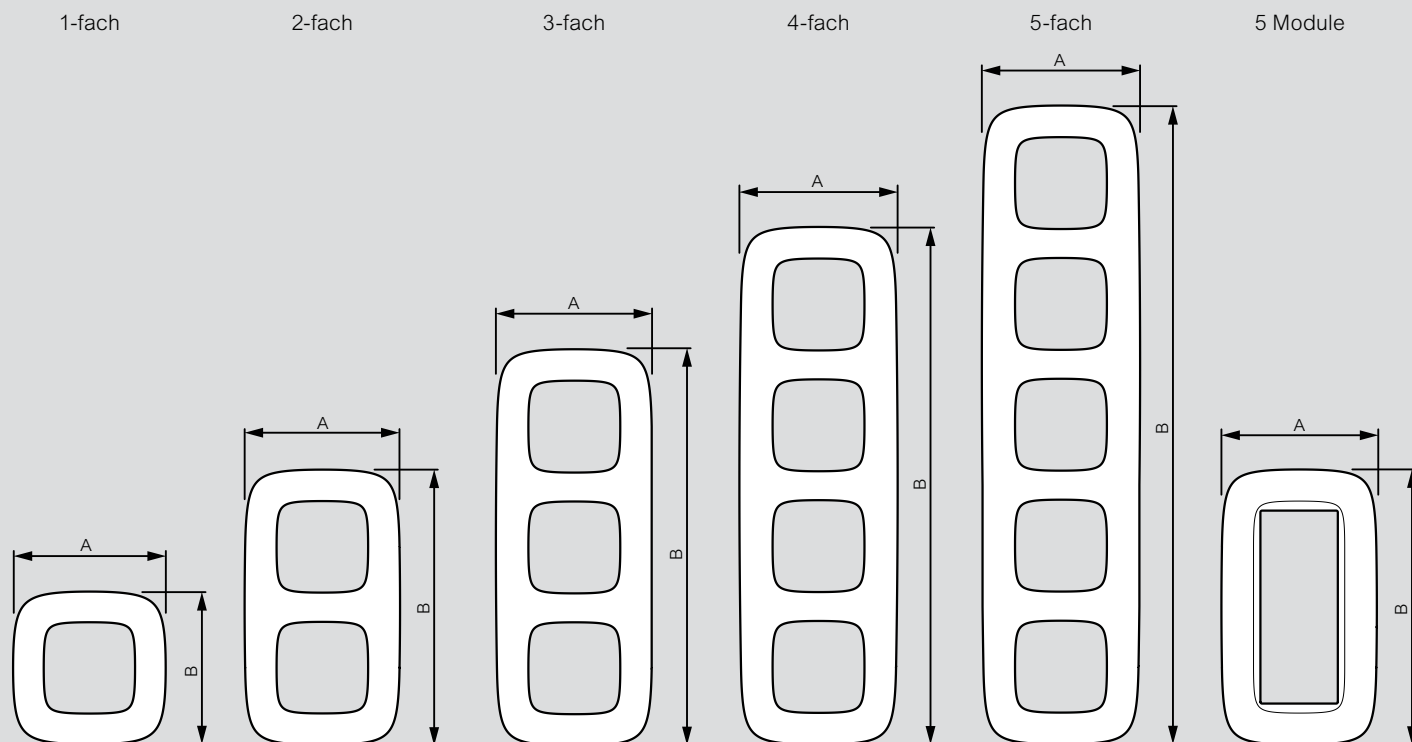























Abmessungen der Abdeckrahmen

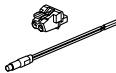

	1-FACH	2-FACH	3-FACH	4-FACH	5-FACH	5 MODULE
Abmessungen	A = 90 mm B = 90 mm	A = 91,5 mm B = 162 mm	A = 92,5 mm B = 233 mm	A = 93 mm B = 304,5 mm	A = 94 mm B = 375,5 mm	A = 91,5 mm B = 162 mm
Ultraweiß	754301	754302	754303	754304	754305	754306
Mandelweiß	754311	754312	754313	754314	754315	754316
Chromestyle	754341	754342	754343	754344	754345	–
Goldstyle	754351	754352	754353	754354	754355	–
Aluminium	754391	754392	754393	754394	754395	754396
Mattschwarz	754401	754402	754403	754404	754405	754406
Perlmutt	754411	754412	754413	754414	754415	754416
Abmessungen	A = 91,5 mm B = 91,5 mm	A = 92,5 mm B = 163 mm	A = 93,5 mm B = 234,5 mm	A = 94,5 mm B = 305,5 mm	A = 95,5 mm B = 377 mm	
White Mirror	754421	754422	754423	754424	754425	–
Leder	754451	754452	754453	754454	754455	–
Walnuss	754461	754462	754463	754464	754465	–
Abmessungen	A = 90 mm B = 90 mm	A = 92 mm B = 162 mm	A = 92,5 mm B = 233,5 mm	A = 93 mm B = 304,5 mm	A = 93 mm B = 374,5 mm	
Marmor	755521	755522	755523	–	–	–
White Glass	755541	755542	755543	755544	755545	–





Valena™ Life

Valena Life und Valena Allure LED Aggregate





Funktion	Best.Nr.	Geeignet für Schalterserie:	
		Valena™ Life 	Valena™ Allure 
LED-AGGREGATE FÜR BELEUCHTETE FUNKTIONEN, FARBE: WEISS			
Steckbares LED-Aggregat für beleuchteten Serienschalter 230 V~ - 0.15 mA 	067684 € 4,38 [14]		
Steckbares LED-Aggregat für beleuchteten Wechselschalter /-taster 230 V~ - 0.15 mA 	067686 € 6,70 [14]		
LED-Aggregat für beleuchteten Kreuzschalter, Flexible Anschlussleitungen; 230 V~ - 0.15 mA 	665090 € 4,52 [26]		
Steckbares LED-Aggregat für beleuchteten Taster, Flexible Anschlussleitungen; 12-24-48V 0,4-1,2-3,7 mA 	067687 € 8,09 [29]		
LED-AGGREGATE FÜR KONTROLL-FUNKTIONEN, FARBE: WEISS			
Steckbares LED-Aggregat für Kontroll-Wechselschalter, zur Verwendung mit Wechselschalter + N-Klemme, 230 V~ - 3 mA, Verwendung mit Best.Nr. 752010 	067688 € 6,70 [29]		
LED-Aggregat für Kontrollfunktionen, Flexible Anschlussleitung; 230 V~ - 3 mA 	665091 € 4,52 [26]		
LED-Aggregat für Steckdosen mit Kontrollfunktion, Flexible Anschlussleitung; 230 V~ - 3 mA 	067664 € 8,67 [14]		
SPEZIELLE LED-AGGREGATE FÜR VALENA ALLURE, FÜR SEITLICHE BELEUCHTUNG, FARBE: BLAU			
Steckbares LED-Aggregat für beleuchteten Wechselschalter 230 V~ - 0.15 mA 	752057 € 9,26 [14]		
Steckbares LED-Aggregat für Kontroll-Wechselschalter, zur Verwendung mit Wechselschalter + N-Klemme, 230 V~ - 3 mA, Verwendung mit Best.Nr. 752010 	752058 € 9,26 [14]		

MyHOME-Rollladen-Steuerung für Pro21



Auswahltabelle für Rollladen Steuerung MyHOME für Galea Life & Creo

MyHOME Aktore und Sensor			Farbauswahl	
			Ultraweiß	
Bezeichnung	Einsatz	Tragring	Adapter Creo	Adapter Galea
MyHOME Tastsensor, 2-fach, Sonder 	067553 € 66,10 [56]	0391F1500 € 2,30 [21]	776767 € 6,05 [21]	771067 € 9,51 [21]
MyHOME Tastsensor, 2-fach 	067552 € 59,95 [56]			
MyHOME Unterputz-Aktor, 2-fach 	067561 € 81,75 [56]			
Pro21 MyHOME Szenarientaster, 4-fach, Ultraweiß 	574503 ⁽¹⁾ € 93,00 [56]			
Pro21 MyHOME Szenarientaster, 8-fach, Ultraweiß/Schwarz 	067592 ⁽¹⁾ € 98,25 [56]			

1: Einsatz inkl. Wippe in Ultraweiß

Wippen Rollladen Steuerung MyHOME		Farbauswahl	
		Ultraweiß	
Bezeichnung	Geeignet für Einsätze	Wippen Creo	Wippen Galea
Pro21 MyHOME Wippe 1 modulig, Auf-Ab, Ultraweiß 	067553 € 66,10 [56]	574493 € 2,10 [21]	574493 € 2,10 [21]
Pro21 MyHOME Wippe 2-modulig, Auf-Ab, Ultraweiß 	067552 € 59,95 [56]	574495 € 3,06 [21]	574495 € 3,06 [21]
Pro21 MyHOME Wippe 1-modulig, Ultraweiß 	067561 € 81,75 [56]	574465 € 1,64 [21]	574465 € 1,64 [21]
Pro21 MyHOME Wippe 2-modulig, Ultraweiß 		574467 € 2,23 [21]	574467 € 2,23 [21]

Hinweis: Systemgeräte finden Sie im Gesamtkatalog im Kapitel MyHOME

Bewegungsmelder und Temperatur Steuerung MyHOME			Farbauswahl	
			Ultraweiß	
Bezeichnung	Einsatz	Tragring	Adapter Creo	Adapter Galea
MyHOME PIR-Bewegungsmelder, Ultraweiß 	574046 € 140,80 [56]	0391F6500 € 2,30 [21]	776767 € 6,05 [21]	771067 € 9,51 [21]
MyHOME Dualtech-Bewegungsmelder, Ultraweiß 	574048 € 155,80 [56]	0391F1500 € 2,30 [21]	776767 € 6,05 [21]	771067 € 9,51 [21]
MyHOME Thermostat mit Display 	067459 € 116,40 [56]	0391F6500 € 2,30 [21]	776767 € 6,05 [21]	771067 € 9,51 [21]









Hinweis: Systemgeräte finden Sie im Gesamtkatalog im Kapitel MyHOME







UNTERPUTZRADIO FÜR VALENA™ LIFE, CREO™ UND GALEA™ LIFE

Beschallung, Bewegungsmelder und Lautwerke





Auswahltabelle fur Soundsystem Galea Life & Creo

UP-Radio mit Display und UP-Lautsprecher		Farbauswahl		
		Ultrawei 	Mandelwei 	Ultrawei 
Bezeichnung	Art Nummer	Adapter Creo	Adapter Creo	Adapter Galea
Valena Life RDS-Radio mit Display Ultrawei 	A75109 € 193,40 [15]	776295 € 3,42 [21]	-	771099 € 5,16 [21]
Valena Life RDS-Radio mit Display Mandelwei 	A75209 € 193,40 [15]	-	776095 € 3,42 [21]	-
Valena Life Lautsprecher Unterputz Ultrawei 	A75110 € 35,75 [16]	776295 € 3,42 [21]	-	771099 € 5,16 [21]
Valena Life Lautsprecher Unterputz Mandelwei 	A75210 € 35,75 [16]	-	776095 € 3,42 [21]	-
Fernbedienung fur Unterputz-Radio mit Display, Grau 	A75014 ⁽¹⁾ € 37,35 [15]	-	-	-

1: wird in der Farbe Grau geliefert

Mosaic Bewegungsmelder				
Mosaic Bewegungsmelder zum Einbau in Creo und Galea Life, 180°			Farbauswahl	
			Ultrawei 	Ultrawei 
Bezeichnung	Art Nummer	Tragring	Adapter Creo	Adapter Galea Life
Mosaic Bewegungsmelder 3L, 180°, 2000W Dualtech 	078452 ⁽¹⁾ € 134,20 [29]	0391F6500 € 2,30 [21]	776767 € 6,05 [21]	771067 € 9,51 [21]
Mosaic Bewegungsmelder 3L, 180°, 2000W 	078454 ⁽¹⁾ € 164,55 [29]	0391F6500 € 2,30 [21]	776767 € 6,05 [21]	771067 € 9,51 [21]
IR-Fernbedienung Standard DLM 			BMSO4003 ⁽²⁾ € 29,25 [56]	

1: Einsatz inkl. Wippe in Ultrawei
2: Farbe Wei

Lautwerke		Farbauswahl	
		Ultrawei 	Ultrawei 
Bezeichnung	Art Nummer	Adapter Creo	Adapter Galea
Gong 12 V~ 	A75111 € 83,65 [16]	A01800 € 2,29 [22]	A01802 € 2,29 [21]
Gong 230 V~ 	A75112 € 86,30 [16]	A01800 € 2,29 [22]	A01802 € 2,29 [21]

VALENA™

LIFE/ALLURE

with
NETATMO

#LoveOfThings



VERNETZTE SCHALTER UND STECKDOSEN

IHR HAUS
GEHORCHT
IHNEN AUFS
WORT



Sprechen

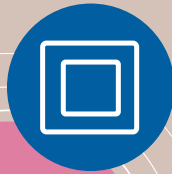

Drücken



Wischen

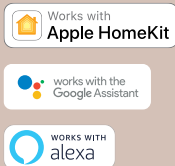

Noch einfacher: Steuern Sie Ihr Zuhause mit Ihrer Stimme, mit Google Assistant, Alexa oder Siri.















Kein herkömmlicher Schalter: jederzeit örtlich veränderbar... aber vernetzt und immer bereit, auf Ihre Berührung zu reagieren.

App Home + Control*
Wo auch immer Sie sind, steuern Sie Ihr Haus mit einem Fingertipp per Tablet oder Smartphone.

*Erhältlich für iOS und Android in den jeweiligen Online-Stores











Valena™ Life with Netatmo





Auswahltabelle (Einsätze inkl. Abdeckungen)

Funktion	VALENA IN'MATIC EINSATZ	VALENA LIFE ABDECKUNGEN			
		Ultraweiß 	Mandelweiß 	Aluminium 	Schwarz 
STARTER-KIT UND ERWEITERUNGSPACK					
Starter-Kit mit Gateway + Steckdose und Masterswitch „Kommen/Gehen“	-	752196 € 135,50 [19]	752296 € 135,50 [19]	752396 € 141,45 [19]	756396 € 141,45 [19]
Erweiterungspack mit Steckdose, Schalter/Dimmer und Wandsender Licht	-	752127 € 140,85 [19]	-	-	-
LICHT SCHALTEN UND DIMMEN					
Schalter/Dimmer 5 – 300 W 	-	752184 € 55,75 [19]	752284 € 55,75 [19]	752384 € 59,95 [19]	756384 € 59,95 [19]
Schalter/Dimmer mit N-Leiter, 150 W 	-	752166 € 71,90 [19]	752266 € 71,90 [19]	752366 € 74,20 [19]	756366 € 74,20 [19]
Serienschalter 2 x 250 W 	-	752188 € 75,30 [19]	752288 € 75,30 [19]	752388 € 78,75 [19]	756388 € 78,75 [19]
Schaltbare Steckdose 16 A 	-	752194 € 50,90 [19]	752294 € 50,90 [19]	752394 € 53,45 [19]	756394 € 53,45 [19]
Mobile Steckdose 16 A 	-	064840 € 74,15 [19]			
Mikromodul Beleuchtung Ein/Aus 300 W 	-	064888 € 47,65 [19]			
Vernetzter Kabelauslass 	-	064879 € 73,00 [19]	064863 € 73,00 [19]	064898 € 76,45 [19]	064847 € 76,45 [19]
Wandsender Licht 1-Fach 	-	752185 € 44,95 [19]	752285 € 44,95 [19]	752385 € 46,20 [19]	756385 € 46,20 [19]
Wandsender Licht 2-Fach 	-	752187 € 68,35 [19]	752287 € 68,35 [19]	752387 € 71,95 [19]	756387 € 71,95 [19]
Bewegungsmelder Aufputz IP44 	-	064875 € 86,40 [19]			
Tasterschnittstelle Licht 	-	067694 € 77,85 [19]			

Valena™ Life with Netatmo

Auswahltabelle (Einsätze inkl. Abdeckungen)

















Funktion	VALENA IN'MATIC EINSATZ	VALENA LIFE ABDECKUNGEN			
		Ultraweiß 	Mandelweiß 	Aluminium 	Schwarz 
ROLLLADEN STEUERN					
Rollladenschalter 	-	752190 € 68,35 [19]	752290 € 68,35 [19]	752390 € 71,95 [19]	756390 € 71,95 [19]
Wandsender Rollladen 	-	752191 € 55,75 [19]	752291 € 55,75 [19]	752391 € 59,95 [19]	756391 € 59,95 [19]
Einbauaktor Rollladen 	-	067697 € 89,00 [19]			
SZENENTASTER					
Masterswitch „Kommen/Gehen“ 	-	752186 € 50,90 [19]	752286 € 51,55 [19]	752386 € 53,95 [19]	756386 € 53,95 [19]
Szenentaster „Tag/Nacht“ 	-	752189 € 55,75 [19]	752289 € 55,75 [19]	752389 € 59,95 [19]	756389 € 59,95 [19]
Szenentaster 4-fach	-	752168 € 64,70 [19]	752268 € 64,70 [19]	752368 € 66,95 [19]	756368 € 66,95 [19]
Handfernbedienung mit 4 Tasten 	-	067695 € 84,15 [19]			

Funktion	VALENA IN'MATIC EINSATZ	VALENA LIFE ABDECKUNGEN			
		Ultraweiß 	Mandelweiß 	Aluminium 	Schwarz 
VORKONFIGURIERTE STAND-ALONE-SETS (NICHT ERWEITERBAR)					
Set mit 1 x Mikromodul und 2 x Wandsender Licht, 1-fach ⁽¹⁾	-	752150 € 106,10 [19]	-	-	-
Set mit 1 x Dimmer und 1 x Wandsender Licht, 1-fach ⁽¹⁾	-	752152 € 106,10 [19]	-	-	-
Set mit 1 x Steckdose 16 A und 1 x Wandsender Licht, 1-fach ⁽¹⁾	-	752154 € 91,75 [19]	-	-	-
Set mit 1 x Rollladenschalter und 1 x Wandsender Rollladen ⁽¹⁾	-	752157 € 116,95 [19]	-	-	-

1: nicht erweiterbar











Valena™ Allure with Netatmo

Auswahltabelle (Einsätze inkl. Abdeckungen)

Funktion	VALENA IN'MATIC EINSATZ	VALENA ALLURE ABDECKUNGEN				
		Ultraweiß 	Mandelweiß 	Aluminium 	Mattschwarz 	Perlmutter 
STARTER-KIT UND ERWEITERUNGSPACK						
Starter-Kit mit Gateway + Steckdose und Masterswitch „Kommen/Gehen“	–	752596 € 135,50 [19]	752696 € 135,50 [19]	752796 € 141,45 [19]	752896 € 141,45 [19]	752996 € 141,45 [19]
LICHT SCHALTEN UND DIMMEN						
Schalter/Dimmer 5 – 300 W 	–	752584 € 55,75 [19]	752684 € 55,75 [19]	752784 € 59,95 [19]	752884 € 59,95 [19]	752984 € 59,95 [19]
Schalter/Dimmer mit N-Leiter, 150 W 	–	752566 € 71,90 [19]	752666 € 71,90 [19]	752766 € 74,20 [19]	752866 € 74,20 [19]	752966 € 74,20 [19]
Serienschalter 2 x 250 W 	–	752588 € 75,30 [19]	752688 € 75,30 [19]	752788 € 78,75 [19]	752888 € 78,75 [19]	752988 € 78,75 [19]
Schaltbare Steckdose 16 A 	–	752594 € 50,90 [19]	752694 € 50,90 [19]	752794 € 53,45 [19]	752894 € 53,45 [19]	752994 € 53,45 [19]
Mobile Steckdose 16 A 	–	064840 € 74,15 [19]				
Mikromodul Beleuchtung Ein/Aus 300 W 	–	064888 € 47,65 [19]				
Vernetzter Kabelauslass 	–	064879 € 73,00 [19]	064863 € 73,00 [19]	064898 € 76,45 [19]	064847 € 76,45 [19]	064851 € 76,45 [19]
Wandsender Licht 1-Fach 	–	752585 € 44,95 [19]	752685 € 44,95 [19]	752785 € 46,20 [19]	752885 € 46,20 [19]	752985 € 46,20 [19]
Wandsender Licht 2-Fach 	–	752587 € 68,35 [19]	752687 € 68,35 [19]	752787 € 71,95 [19]	752887 € 71,95 [19]	752987 € 71,95 [19]
Bewegungsmelder Aufputz IP44 	–	064875 € 86,40 [19]				
Tasterschnittstelle Licht 	–	067694 € 77,85 [19]				

Valena™ Allure with Netatmo

Auswahltabelle (Einsätze inkl. Abdeckungen)

Funktion	VALENA IN'MATIC EINSATZ	VALENA ALLURE ABDECKUNGEN					
		Ultraweiß 	Mandelweiß 	Aluminium 	Mattschwarz 	Perlmutter 	
ROLLLADEN STEUERN							
Rollladenschalter		-	752590 € 68,35 [19]	752690 € 68,35 [19]	752790 € 71,95 [19]	752890 € 71,95 [19]	752990 € 71,95 [19]
Wandsender Rollladen		-	752591 € 55,75 [19]	752691 € 55,75 [19]	752791 € 59,95 [19]	752891 € 59,95 [19]	752991 € 59,95 [19]
Einbauaktor Rollladen		-	067697 € 89,00 [19]				
SZENENTASTER							
Masterswitch „Kommen/Gehen“		-	752586 € 51,55 [19]	752686 € 51,55 [19]	752786 € 53,95 [19]	752886 € 53,95 [19]	752986 € 53,95 [19]
Szenentaster „Tag/Nacht“		-	752589 € 55,75 [19]	752689 € 55,75 [19]	752789 € 59,95 [19]	752889 € 59,95 [19]	752989 € 59,95 [19]
Szenentaster 4-fach		-	752568 € 64,70 [19]	752668 € 64,70 [19]	752768 € 66,95 [19]	752868 € 66,95 [19]	752968 € 66,95 [19]
Handfernbedienung mit 4 Tasten		-	067695 € 84,15 [19]				

CREO™



DEZENTES DESIGN IN BEWÄHRTER FORM

Bewährtes Design

Creo™ ist das bewährte Design.
Dezent, aber dennoch unverwechselbar.
Es ist die richtige Wahl für alle, die Wert
auf Qualität und funktionelle Gestaltung legen.















Ultraweiß



Mandelweiß







Schalterprogramm Creo™

Rahmen, Wippen

Funktion	 Geeignet für Einsatz	 Symbol	Farbauswahl	
			Mandelweiß 	Ultraweiß 
RAHMEN für horizontale oder vertikale Montage, putzausgleichend, Zentrierstege für passgenaue Montage				
1-fach, 82 x 82 mm (Außenmaß)			776001 € 3,21 [21]	776201 € 3,21 [21]
2-fach, 82 x 153 mm (Außenmaß)			776002 € 5,54 [21]	776202 € 5,48 [21]
3-fach, 82 x 224 mm (Außenmaß)			776003 € 9,23 [21]	776203 € 9,23 [21]
4-fach, 82 x 295 mm (Außenmaß)			776004 € 15,70 [21]	776204 € 15,70 [21]
5-fach, 82 x 366 mm (Außenmaß)			776005 € 25,70 [21]	776205 € 25,70 [21]
1-fach mit Beschriftungsfeld, 82 x 82 mm, inkl. Beschriftungsetiketten			-	776209 € 7,26 [21]
WIPPEN VOLLE PLATTE 82 X 82 MM FÜR EINZELMONTAGE Wippe mit Rahmen vormontiert				
Aus-/Wechselschalter	775806 € 9,99 [21]	Universalwippe + Rahmen Neutral 	776110 € 7,12 [21]	776160 € 7,12 [21]
Kreuzschalter	775807 € 20,15 [21]			
Taster Schließer	775811 € 11,35 [21]			
Universaltaster Wechsler	775816 € 11,85 [21]			
Aus-/Wechselschalter, beleuchtet	775602 € 25,55 [21]	Kontrollwippe + Rahmen Wippe mit eingesetztem Fenster 	776111 € 9,13 [21]	776161 € 9,13 [21]
Kreuzschalter, beleuchtet	775827 € 27,95 [21]			
Taster Schließer, beleuchtet	775813 € 18,20 [21]			
Taster Schließer Kontroll	775817 € 22,25 [21]			
Aus-/Wechselschalter Kontroll	775820 € 25,55 [21]			







Schalterprogramm Creo™

Wippen

Funktion	 Geeignet für Einsatz	 Symbol	Farbauswahl	
			Mandelweiß 	Ultraweiß 
WIPPEN VOLLE PLATTE 82 X 82 MM FÜR EINZELMONTAGE Wippe mit Rahmen vormontiert				
Serienschalter	775805 € 15,50 [21]	Serienwippe + Rahmen Neutral 	776112 € 10,35 [21]	776162 € 10,35 [21]
Doppelwechschler	775808 € 26,45 [21]			
Doppeltaster 2 Wechsler	775818 € 27,05 [21]			
Taster Wechsler/Wechschler	775810 € 28,25 [21]			
WIPPEN FÜR KOMBINATIONSMONTAGE , Gegenplatte bereits auf Wippe vormontiert				
Aus-/Wechsler	775806 € 9,99 [21]	Universalwippe Neutral 	776010 € 4,26 [21]	776210 € 4,26 [21]
Kreuzschalter	775807 € 20,15 [21]			
Taster Schließer	775811 € 11,35 [21]			
Universaltaster Wechsler	775816 € 11,85 [21]			
Wechsler 16 A	775606 € 36,65 [21]			
Aus-/Wechsler, beleuchtet	775602 € 25,55 [21]	Kontrollwippe mit eingesetztem transparentem Fenster 	776008 € 5,79 [21]	776208 € 5,79 [21]
Aus-/Wechsler Kontroll	775820 € 25,55 [21]			
Kreuzschalter, beleuchtet	775827 € 27,95 [21]			
Taster Schließer, beleuchtet	775813 € 18,20 [21]			
Taster Schließer Kontroll	775817 € 22,25 [21]			
Taster Wechsler, beleuchtet	775846 € 18,90 [21]			
Aus-/Wechsler, beleuchtet, 16 A	775609 € 43,10 [21]			











Schalterprogramm Creo™

Wippen

Funktion	 Geeignet für Einsatz	 Symbol	Farbauswahl			
			Mandelweiß 	Ultraweiß 		
WIPPEN FÜR KOMBINATIONSMONTAGE , Gegenplatte bereits auf Wippe vormontiert						
Aus-/Wechselschalter, beleuchtet	775602 € 25,55 [21]	Kontrollwippe mit eingesetztem Fenster inkl. Piktogrammscheibe mit 4 Symbolen (neutral, Rot, Licht, Glocke) 				
Aus-/Wechselschalter Kontroll	775820 € 25,55 [21]					
Aus-/Wechselschalter, 16 A	775609 € 43,10 [21]					
Kreuzschalter, beleuchtet	775827 € 27,95 [21]				776011 € 7,08 [21]	776211 € 7,08 [21]
Taster Schließer, beleuchtet	775813 € 18,20 [21]					
Taster Schließer Kontroll	775817 € 22,25 [21]					
Taster Wechsler, beleuchtet	775846 € 18,90 [21]					
Serienschalter	775805 € 15,50 [21]	Serienwippe Neutral 				
Doppelwechselschalter	775808 € 26,45 [21]					
Doppeltaster 2 Wechsler	775818 € 27,05 [21]				776012 € 7,79 [21]	776212 € 7,79 [21]
Taster Wechsler/Wechselschalter	775810 € 28,25 [21]					
Serienschalter, beleuchtet	775825 € 33,85 [21]	Serienwippe Kontroll mit eingesetztem transparentem Fenster 				
Serienschalter Kontroll	775869 € 46,20 [21]				-	776213 € 11,25 [21]
Doppelwechselschalter, beleuchtet	775608 € 38,40 [21]					

Schalterprogramm Creo™











Wippen

Funktion	 Geeignet für Einsatz	 Symbol	Farbauswahl	
			Mandelweiß 	Ultraweiß 
WIPPEN FÜR KOMBINATIONSMONTAGE , Gegenplatte bereits auf Wippe vormontiert (Fortsetzung)				
Jalousieschalter	775804 € 27,65 [21]	Jalousiewippe mit aufgedruckten Pfeilsymbolen 	776014 € 10,75 [21]	776214 € 10,75 [21]
Jalousietaster	775814 € 27,25 [21]			
Aus-/Wechselschalter	775806 € 9,99 [21]	Wippe mit Beschriftungsfeld inkl. Beschriftungsetiketten 		
Kreuzschalter	775807 € 20,15 [21]			
Taster Schließer	775811 € 11,35 [21]			
Universaltaster Wechsler	775816 € 11,85 [21]			
Kreuzschalter, beleuchtet	775827 € 27,95 [21]			
Wechselschalter, 16 A	775606 € 36,65 [21]			
Ausschalter, 2-polig	775802 € 21,80 [21]	Wippe mit Aufdruck 0/I 	-	776215 € 5,72 [21]
Ausschalter, 3-polig	775803 € 37,65 [21]			
Ausschalter, 2-polig, Kontroll/beleuchtet	775822 € 34,35 [21]	Wippe Kontroll mit Aufdruck 0/I und eingesetztem transparentem Fenster 	-	776218 € 7,13 [21]
Ausschalter, 2-polig, Kontroll/beleuchtet	775822 € 34,35 [21]	Wippe Kontroll Rot RAL 3000 mit Aufdruck 0/1 und „Heizung Notschalter“ 	776216 € 13,45 [22]	
Set mit 8 Piktogrammscheiben für Kontrollwippen Einsetzen in Kontrollwippen Best.Nr. 776x11			775800 € 4,61 [21]	

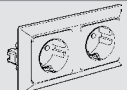
1: Lieferzeit auf Anfrage

Schalterprogramm Creo™

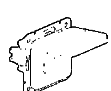







Steckdosen

Funktion	 Geeignet für Einsatz	 Symbol	Farbauswahl	
			Mandelweiß 	Ultraweiß 
SCHUTZKONTAKT-STECKDOSEN, 16 A/250 V~ VOLLE PLATTE FÜR EINZELMONTAGE Für Spreiz- und Schraubbefestigung, Anschlüsse mit schraublosen Verbindungsklemmen (SL) oder Schraubklemmen (SK)				
Steckdose (SL), 1-fach Kompletgerät, 82 x 82 mm			776120 ⁽¹⁾ € 7,78 [21]	776170 ⁽¹⁾ € 7,78 [21]
Steckdose (SL), 2-fach, horizontal Kompletgerät, 82 x 153 mm			776122 ⁽¹⁾ € 15,60 [21]	776172 ⁽¹⁾ € 15,60 [21]
Steckdose (SK), 2-fach, vertikal Kompletgerät, 82 x 112 mm Passend für eine 1-fach Schalterdose		ohne Abb.	776123 ⁽¹⁾ € 15,60 [21]	776173 ⁽¹⁾ € 15,60 [21]
SCHUTZKONTAKT-STECKDOSEN, 16 A/250 V~ VOLLE PLATTE FÜR KOMBINATIONSMONTAGE Einsatz mit Abdeckung 55 x 55 mm, für Spreiz- und Schraubbefestigung, Anschlüsse mit schraublosen Verbindungsklemmen (SL) oder Schraubklemmen (SK)				
Steckdose (SL) Nachträglich beschriftbar durch aufsteckbaren Beschriftungsträger Best.Nr. 776000			776020 ⁽¹⁾ € 6,93 [21]	776220 ⁽¹⁾ € 6,93 [21]
Steckdose (SL) mit erhöhtem Berührungsschutz Nachträglich beschriftbar durch aufsteckbaren Beschriftungsträger Best.Nr. 776000			776022 ⁽¹⁾ € 9,98 [21]	776222 ⁽¹⁾ € 10,00 [21]
Steckdose (SL) mit Klappdeckel und erhöhtem Berührungsschutz Flacher Klappdeckel			776024 ⁽¹⁾ € 15,15 [21]	776224 ⁽¹⁾ € 15,15 [21]
Steckdose (SL) mit Klappdeckel, Beschriftungsfeld und erhöhtem Berührungsschutz Geliefert mit Beschriftungsetiketten			-	776226 ⁽¹⁾ € 22,15 [21]
Steckdose (SL) mit erhöhtem Berührungsschutz und Beschriftungsträger Geliefert mit Beschriftungsetiketten			776028 ⁽¹⁾ € 15,60 [21]	776228 ⁽¹⁾ € 14,10 [21]

1: inkl. Einsatz

Schalterprogramm Creo™

Steckdosen

Funktion	 Geeignet für Einsatz	 Symbol	Farbauswahl	
			Mandelweiß 	Ultraweiß 
SCHUTZKONTAKT-STECKDOSEN, 16 A/250 V~ FÜR WSV, SV UND ZSV Zur Kennzeichnung bestimmter Stromkreise: WSV: Weitere Sicherheits-Stromversorgung, SV: Sicherheits-Stromversorgung, ZSV: Zusätzliche Sicherheits-Stromversorgung				
Steckdose (SL) Rot mit Beschriftungsträger und erhöhtem Berührungsschutz Für weitere Sicherheits-Stromversorgung (WSV)				776229 ⁽¹⁾ € 15,75 [22]
Steckdose (SL) Grün mit Beschriftungsträger und erhöhtem Berührungsschutz Für Sicherheits-Stromversorgung (SV)				776234 ⁽¹⁾ € 16,75 [22]
Steckdose (SL) Orange mit Beschriftungsträger und erhöhtem Berührungsschutz Für zusätzliche Sicherheits-Stromversorgung (ZSV)				776242 ⁽¹⁾ € 16,75 [22]
SCHUTZKONTAKT-STECKDOSEN, 16 A/250 V~ VERWECHSLUNGSSICHER Zum Schutz von bestimmten Stromkreisen Das mitgelieferte Codierplättchen muss am Stecker befestigt sein.				
Steckdose (SK) Rot verwechslungssicher Mit Beschriftungsträger				776230 ⁽¹⁾ € 32,65 [22]
Ersatz-Codierplättchen Für verwechslungssichere Steckdosen Zum Aufkleben auf die zu codierenden Stecker				050299 € 5,34 [43]













1: inkl. Einsatz

STECKDOSEN, 16 A/250 V~ FRANZÖSISCHER STANDARD Einsatz mit Abdeckung 55 x 55 mm, für Spreiz- und Schraubbefestigung				
Steckdose (SK) mit erhöhtem Berührungsschutz Nachträglich beschriftbar durch aufsteckbaren Beschriftungsträger Best.Nr. 776000				776247 € 51,45 [21]

1: Lieferzeit auf Anfrage

Schalterprogramm Creo™

Abdeckungen

Funktion	 Geeignet für Einsatz	 Symbol	Farbauswahl	
			Mandelweiß 	Ultraweiß 
DREHDIMMER				
Druck-Wechseldimmer, 1000 W, Phasenabschnitt	775910 € 239,70 [31]		-	776259 € 13,05 [21]
Drehdimmer 40 – 400 W, Phasenanschnitt	775654 € 44,00 [31]		776668 € 8,18 [21]	776768 € 8,18 [21]
Elektronischer Tastpotentiometer	078404 € 136,45 [29]		-	776767 + 0391F6500 € 6,05 + € 2,30 [21] [21]
WIPPEN/ABDECKUNGEN FÜR TASTDIMMER UND BEWEGUNGSMELDER				
Universal-Tastdimmer 400 W, Phasen-/abschnitt	775652 € 175,00 [31]		776686 € 9,52 [21]	776786 € 9,52 [21]
Tastdimmer Phasenanschnitt 600 W, Phasenabschnitt	775653 € 83,25 [31]			
LED-Tastdimmer 400 W, ohne Neutraleiter, Phasen-/abschnitt	775659 € 128,45 [31]			
BEWEGUNGSMELDER PRO 21™/CREO™ mit Schraubklemmen, geeignet für Spreizkrallen- und Schraubbefestigung				
Bewegungsmelder 2-Leiter 180°, mit/ohne Handschalter, parallelschaltbar	-		A77662 ⁽¹⁾ € 192,15 [31]	A77672 ⁽¹⁾ € 192,15 [31]
Bewegungsmelder 3-Leiter 180°, mit/ohne Handschalter, parallelschaltbar, Nebenstelleneingang	-		A77663 ⁽¹⁾ € 159,95 [31]	A77673 ⁽¹⁾ € 159,95 [31]
Bewegungsmelder 3-Leiter ohne Handbetätigung, 120°⁽²⁾	-		775773 + 999873 ⁽¹⁾ € 52,05 + € 6,49 [31] [21]	775773 ⁽¹⁾ € 52,05 [31]
Bewegungsmelder 2-Leiter mit Handbetätigung, 120°⁽³⁾	-		775772 + 999872 ⁽¹⁾ € 134,35 + € 6,16 [31] [21]	775772 ⁽¹⁾ € 134,35 [31]
FERNSCHALTER				
Fernschalter Doseneinbau	049120 € 63,45 [43]		-	-

1: inkl. Einsatz

2: Für folgende Lastarten geeignet:

- Glüh- und HV-Halogenlampen: 3 - 250 W

- LEDs, Leuchtstoff- und Kompaktleuchtstofflampen und NV-Halogenlampen mit elektronischem oder konventionellem Vorschaltgerät: 3 - 250 VA

- LED- oder Kompaktleuchtstofflampen: 3 - 100 W, Parallelschaltung mehrerer Bewegungsmelder möglich, (max. 2 zusätzliche Sensoren).

Die Einstellungen werden mittels Potentiometer durchgeführt.

3: Für folgende Lastarten geeignet:

- Glüh- und HV-Halogenlampen: bis 400 W

- LEDs, Leuchtstoff- und Kompaktleuchtstofflampen und NV-Halogenlampen mit elektronischem oder konventionellem Vorschaltgerät: bis 200 VA













- LED- oder Kompaktleuchtstofflampen: bis 50 W, Parallelschaltung mehrerer Bewegungsmelder möglich.

Die Einstellungen werden mittels Potentiometer durchgeführt.

4: Lieferzeit auf Anfrage







Schalterprogramm Creo™

Abdeckungen

Funktion	 Geeignet für Einsatz	 Symbol	Farbauswahl	
			Mandelweiß 	Ultraweiß 
ANTENNE AUSFÜHRUNG HIRSCHMANN, 3-LOCH				
Mit ausbrechbarer SAT-Öffnung, nachträglich beschriftbar durch aufsteckbaren Beschriftungsträger Best.Nr. 776000				
TV Einzeldose	775981 € 26,45 [21]	2-/3-Loch 	776082 € 6,23 [21]	776282 € 6,24 [21]
TV Durchgangsdose	775984 € 29,05 [21]			
SAT Einzeldose	775983 € 31,65 [21]			
ANTENNE AUSFÜHRUNG 5-LOCH				
Ausführung WISI, Ankaro, Hirschmann		5-Loch 	-	776280 € 7,67 [21]
ANTENNE AUSFÜHRUNG LEGRAND				
TV Einzeldose	775786 € 23,50 [21]	TV-R, 2-Loch 	776672 € 7,89 [21]	776772 € 7,89 [21]
TV Enddose	775787 € 23,50 [21]			
TV Durchgangsdose	775788 € 23,50 [21]			
TV Einzeldose	775789 € 26,35 [21]	TV-R-SAT, 3-Loch 	-	776773 € 7,89 [21]
TV Enddose	775790 € 26,35 [21]			
TV Durchgangsdose	775791 € 26,35 [21]			
TELEFON				
Abdeckung TDO für Telefon-Steckdose Österreich	775990 € 48,75 [21]		776090 € 6,03 [21]	776290 € 6,03 [21]
Abdeckung TAE für Telefon-Steckdose Deutschland	775991 € 14,85 [21]		776091 € 6,35 [21]	776291 € 6,35 [21]
HI-FI LAUTSPRECHER-ANSCHLUSSEINHEIT				
Abdeckung für Anschlusseinheit, 1-fach	775785 € 16,95 [31]		-	776700 € 8,05 [21]
Abdeckung für Anschlusseinheit, 2-fach	775784 € 21,35 [31]		-	776715 € 8,41 [21]





Schalterprogramm Creo™

Abdeckungen

Funktion	 Geeignet für Einsatz	 Symbol	Farbauswahl	
			Mandelweiß 	Ultraweiß 
DATENANSCHLUSSTECHNIK				
DAE UTP 1 x RJ45, Kategorie 5e	775761 € 25,65 [21]	Auslass 30° mit Beschriftungsträger 	776075 € 7,59 [21]	776275 € 7,59 [21]
DAE UTP 2 x RJ45, Kategorie 5e	775762 € 33,30 [21]			
DAE UTP 1 x RJ45, Kategorie 6	775828 € 27,15 [31]			
DAE UTP 2 x RJ45, Kategorie 6	775830 € 36,55 [31]			
DAE FSTP 1 x RJ45, Kategorie 6	775767 € 31,75 [21]			
DAE FSTP 2 x RJ45, Kategorie 6	775768 € 41,30 [21]			
DATENDOSE SYSTEM LSA-PLUS Fabrikat Rutenbeck, BTR, Telegärtner				
DAE FSTP 2 x RJ45, Kategorie 6A	775976 € 42,10 [31]		776658 € 7,63 [21]	776758 € 7,63 [21]
DAE FSTP 2 x RJ45, Kategorie 5e	775887 € 43,95 [31]			

Schalterprogramm Creo™





Abdeckungen

Funktion	 Geeignet für Einsatz	 Symbol	Farbauswahl	
			Mandelweiß 	Ultraweiß 
UNIVERSAL-ABDECKUNG				
Drucktaster Mandelweiß	775843 € 34,15 [21]	Abdeckung mit Ausnehmung Ø 46,5 mm 		
Drucktaster Ultraweiß	775844 € 29,70 [21]			
Zugschalter	775809 € 29,00 [21]			
Zugtaster	775819 € 29,00 [21]			
Lichtsignal	775940 € 27,85 [21]			
Kombigerät Taster/Schalter, Ultraweiß	775558 € 94,45 [21]			
Potentialausgleichssteckdose	775988 € 46,90 [21]			
Summer Ultraweiß 230 V~	775712 € 33,85 [31]			
Rollladenschaltuhr Ultraweiß	775746 € 163,25 [31]			
Gong 12 V~	A75111 € 83,65 [16]			
Gong 230 V~	A75112 € 86,30 [16]			

1: Lieferzeit auf Anfrage







Schalterprogramm Creo™













Abdeckungen

Funktion	 Geeignet für Einsatz	 Symbol	Farbauswahl	
			Mandelweiß 	Ultraweiß 
UNIVERSAL-ABDECKUNG				
Raumtemperaturregler Standard Mandelweiß	775812 € 134,85 [31]	Abdeckung mit Ausnehmung Ø 46,5 mm 	776019 € 6,21 [21]	776219 € 6,21 [21]
Raumtemperaturregler Standard Ultraweiß	775815 € 134,85 [31]			
Raumtemperaturregler Komfort Ultraweiß	775867 € 142,45 [31]			
Raumtemperaturregler Fußbodenheizung Ultraweiß	775858 € 223,50 [31]			

Schalterprogramm Creo™

Abdeckungen







Funktion	 Geeignet für Einsatz	 Symbol	Farbauswahl	
			Mandelweiß 	Ultraweiß 
DREH- UND ZEITSCHALTER				
Zeitschalter 0 – 15 Min.	775962 € 85,95 [21]	Abdeckung mit Knebelknopf 	776057 € 8,39 [21]	776257 € 8,39 [21]
Zeitschalter 0 – 120 Min.	775964 € 91,75 [21]			
Stufenschalter Jalousie	775853 € 44,20 [21]			
3-Stufenschalter ohne Nullstellung	775957 € 70,50 [21]			
3-Stufenschalter mit Nullstellung	775958 € 76,20 [21]			
1-Stufenschalter mit Nullstellung	775959 € 59,70 [21]			
LEITUNGS AUSLASS				
Leitungsauslass mit Klemmen	775985 € 12,70 [21]		776085 € 6,23 [21]	776285 € 6,23 [21]
Leitungsauslass ohne Klemmen	775986 € 10,45 [21]			
BLINDABDECKUNG				
Blindabdeckung mit Tragring Nachträglich beschriftbar durch aufsteckbaren Beschriftungsträger Best.Nr. 776000	–		776078 € 11,45 [21]	776278 € 11,45 [21]

Funktion	 Geeignet für Einsatz	 Symbol	Farbauswahl	
			Mandelweiß 	Ultraweiß 
HOTEL-CARD				
Hotel-Card	775954 € 41,85 [21]	Abdeckung mit Beschriftungsfeld für mechanischen Hotel-Card-Schalter 	-	776254 € 29,70 [21]
MELDE- UND BEFEHLSGERÄTE Für den Einbau von Drucktastern, Drehschaltern, Schlagtastern, Schlüsseltastern und Meldeleuchten				
Abdeckung mit Tragrिंग, Öffnung Ø 22,5 mm	-		-	776293 € 12,10 [21]
NOTSCHALTER 10 A/250 V~ Für Schraubbefestigung: Anschlüsse mit Schraubklemmen (SK) Wird geliefert mit 1 Schließer- und 1 Öffnerkontakt. Diese können beliebig durch Öffner- (Best.Nr. 022901) oder Schließerkontakte (Best.Nr. 022902) ersetzt werden. Max. 2 Kontakte bestückbar.				
Abdeckung Gelb mit Tragrिंग und rotem Pilzknopf (Ø 40 mm) Schaltkontakt: 1 Schließer, 1 Öffner, Entriegelung durch Ziehen	-			776294 ⁽¹⁾ € 74,20 [22]
Abdeckung Gelb mit Tragrिंग und rotem Pilzknopf (Ø 40 mm) mit Schloss Schaltkontakt: 1 Schließer, 1 Öffner, Entriegelung durch Schlüssel (geliefert mit 2 Schlüsseln)	-			776198 ⁽¹⁾ € 90,35 [22]
ADAPTER 45 X 45 MILLIMETER				
Zwischenrahmen für Sondergeräte 45 x 45 mm Geeignet für Einbaugeräte mit Abdeckung 45 x 45 mm	-		-	776767 € 6,05 [21]
ADAPTER 50 X 50 MILLIMETER				
Zwischenrahmen für Datendosen Geeignet für Einbaugeräte mit Abdeckung 50 x 50 mm nach DIN 49075	-		776095 € 3,42 [21]	776295 € 3,42 [21]
BESCHRIFTUNGSTRÄGER Für Creo™-Abdeckungen, zum nachträglichen Beschriften				
Aufsteckbarer Beschriftungsträger Geliefert mit Beschriftungsetiketten	-			776000 € 4,11 [21]
DIN-PROFIL-HALBZYLINDER (nicht für Aufputz-Gehäuse geeignet)				
DIN-Profil-Halbzylinder	077074 € 90,80 [29]		-	776767 + 0391F6500 € 6,05 + € 2,30 [21] [21]

1: inkl. Einsatz





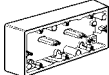



Schalterprogramm Creo™

Aufputzgehäuse

Funktion	 Geeignet für Einsatz	 Symbol	Farbauswahl	
			Mandelweiß 	Ultraweiß 
AUFPUTZ-GEHÄUSE Für vertikale oder horizontale Montage				
Aufputz-Gehäuse, 1-fach Abmessungen L x B x T: 90 x 90 x 36 mm (Außenmaß)	–		776131 € 12,35 [21]	776181 € 12,35 [21]
Aufputz-Gehäuse, 2-fach Abmessungen L x B x T: 90 x 161 x 36 mm (Außenmaß)	–		776132 € 22,65 [21]	776182 € 22,65 [21]
Aufputz-Gehäuse, 3-fach Abmessungen L x B x T: 90 x 232 x 36 mm	–		776133 € 38,95 [21]	–

Schalterprogramm Creo™

Einsätze Feuchtraum Unterputz IP 44

Funktion	 Geeignet für Einsatz	 Symbol	Farbauswahl	
			Mandelweiß 	Ultraweiß 
WIPPSCHALTER/-TASTER, 10 A/250 V~ (ZUR VERWENDUNG MIT STANDARDRAHMEN)				
Einsatz Universal Aus-/Wechselschalter 1-polig mit Wippe	–		–	776701 ⁽¹⁾⁽²⁾ € 23,50 [24]
Einsatz Serienschalter mit Wippe	–		–	776702 ⁽¹⁾⁽²⁾ € 28,40 [24]
Einsatz Taster Schließer 1-polig mit Wippe	–		–	776704 ⁽¹⁾⁽²⁾ € 24,60 [24]
FEUCHTRAUM-DICHTUNGSSETS (ZUR VERWENDUNG MIT STANDARDRAHMEN)				
FR-Wippe mit Piktogrammscheibe + Dichtungstopf Als Abdeckung für Pro 21 Schalter und Taster mit Piktogrammscheibe (Glocke, Licht, weißes und rotes Leerfeld)	–	ohne Abb.	–	776751 € 25,15 [24]
FR-Serienwippe + Dichtungstopf Als Abdeckung für Pro 21 Serien- und Doppelwechselschalter sowie Doppeltaster	–	ohne Abb.	–	776752 € 20,70 [24]
SCHUTZKONTAKT-STECKDOSE 16 A/250 V~ (ZUR VERWENDUNG MIT STANDARDRAHMEN)				
Schutzkontakt-Steckdose (SL) mit Klappdeckel und erhöhtem Berührungsschutz	–		–	776708 ⁽¹⁾⁽²⁾ € 21,60 [24]

1: inkl. Einsatz

2: Für die IP 44-Einsätze werden die Standard-Abdeckrahmen zur Komplettierung verwendet.



PRO 21™

GEBÄUDEINSTALLATION

KOMFORTABEL GEMACHT

Der Schalter- einsatz

Der bewährte Schaltereinsatz, ausgezeichnet für seine Ergonomie und Funktionalität, macht Ihre Arbeit schneller und sicherer.

Sein innovativer allseitiger Berührungsschutz bietet rundum optimale Sicherheit, weil zwischen Tragring und Spreizkrallen keine leitende Verbindung besteht. Clever sind auch die großen, trichterförmigen Drahteinführungen, die schnelles Arbeiten leicht machen.



Bewegungsmelder mit Handschalter



Universal Tastdimmer



Thermostat



Drehdimmer

Elektronische Funktionen

Das Pro 21™-Sortiment umfasst zahlreiche elektronische Funktionen mit optimalem Bedienkomfort. Damit bieten Sie Ihren Kunden passend zu jedem Lebensstil die perfekte Lösung, mit der das Leben einfacher, bequemer und sicherer wird.

GALEA™ LIFE



ATTRAKTIVES DESIGN, BEWÄHRTE TECHNOLOGIE

Passt zu Ihrem Heim

Das Design von Galea™ Life ist so individuell wie das Leben selbst. Lassen Sie sich inspirieren von Farben und Materialien.











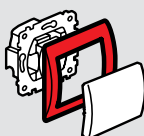

Ultraweiß

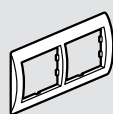

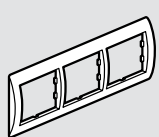
Brushed Aluminium/
Soft Aluminium

Schalterprogramm Galea™ Life







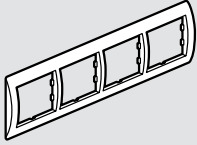

Rahmen Kunststoff, Metall, Holz, Corian®, Leder

MATERIAL	Rahmen					
						
	1-fach 83 × 91 mm	2-fach horizontal 83 × 162 mm	2-fach vertikal 91 × 154 mm	3-fach horizontal 83 × 233 mm	3-fach vertikal 91 × 225 mm	
KUNSTSTOFF	Ultraweiß 	771001 + 771013 ⁽¹⁾ € 5,62 + € 9,79 [21] [21]	771002 + 771014 ⁽¹⁾ € 9,54 + € 15,70 [21] [21]	771006 € 9,54 [21]	771003 + 771015 ⁽¹⁾ € 16,50 + € 26,85 [21] [21]	771007 € 16,50 [21]
	Dark Bronze 	771201 € 7,32 [22]	771202 € 12,50 [22]	771206 € 12,50 [22]	771203 € 21,50 [22]	771207 € 21,50 [22]
	Soft Aluminium 	771301 € 7,32 [22]	771302 € 12,50 [22]	771306 € 12,50 [22]	771303 € 21,50 [22]	771307 € 21,50 [22]
	Titanium 	771401 € 7,32 [22]	771402 € 12,50 [22]	771406 € 12,50 [22]	771403 € 21,50 [22]	771407 € 21,50 [22]
	Perlmutter 	771501 € 7,32 [22]	771502 € 12,50 [22]	771506 € 12,50 [22]	771503 € 21,50 [22]	771507 € 21,50 [22]

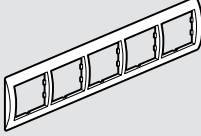
1: Rahmen mit Beschriftungsfeld für flexible Beschriftung siehe Beschriftungsträger Best.Nr. 771100
2: Lieferzeit auf Anfrage









Schalterprogramm Galea™ Life

Rahmen Kunststoff, Metall, Holz, Corian®, Leder

MATERIAL	Rahmen				
		4-fach horizontal 83 × 304 mm	4-fach vertikal 91 × 296 mm	5-fach horizontal 83 × 375 mm	5-fach vertikal 91 × 367 mm
KUNSTSTOFF	Ultraweiß 	771004 € 24,85 [21]	771008 € 24,75 [21]	771005 € 35,50 [21]	771009 € 35,50 [21]
	Dark Bronze 	771204 € 32,65 [22]	771208 € 32,65 [22]	771205 € 46,50 [22]	771209 € 46,50 [22]
	Soft Aluminium 	771304 € 32,65 [22]	771308 € 32,65 [22]	771305 € 46,50 [22]	771309 € 46,50 [22]
	Titanium 	771404 € 32,65 [22]	771408 € 32,65 [22]	771405 € 46,50 [22]	771409 € 46,50 [22]
	Perlmutter 	771504 € 32,65 [22]	771508 € 32,65 [22]	771505 € 46,50 [22]	771509 € 46,50 [22]







Schalterprogramm Galea™ Life

Wippen

Funktion	 Geeignet für Einsatz	 Symbol	Farbauswahl				
			Ultraweiß 	Dark Bronze 	Soft Aluminium 	Titanium 	Perlmutter 
WIPPEN FÜR KOMBINATIONSMONTAGE Gegenplatte bereits auf Wippe vormontiert							
Aus-/Wechselschalter	775806 € 9,99 [21]	Universalwippe Neutral 					
Kreuzschalter	775807 € 20,15 [21]						
Taster Schließer	775811 € 11,35 [21]						
Universaltaster Wechsler	775816 € 11,85 [21]						
Wechselschalter, 16 A	775606 € 36,65 [21]						
Aus-/Wechselschalter, beleuchtet	775602 € 25,55 [21]	Kontrollwippe 					
Aus-/Wechselschalter Kontroll	775820 € 25,55 [21]						
Kreuzschalter, beleuchtet	775827 € 27,95 [21]						
Taster Schließer, beleuchtet	775813 € 18,20 [21]						
Taster Schließer Kontroll	775817 € 22,25 [21]						
Taster Wechsler, beleuchtet	775846 € 18,90 [21]						
Aus-/Wechselschalter, beleuchtet, 16 A	775609 € 43,10 [21]						









Schalterprogramm Galea™ Life

Wippen

Funktion	 Geeignet für Einsatz	 Symbol	Farbauswahl				
			Ultraweiß	Dark Bronze	Soft Aluminium	Titanium	Perlmutter
WIPPEN FÜR KOMBINATIONSMONTAGE Gegenplatte bereits auf Wippe vormontiert (Fortsetzung)							
Aus-/Wechselschalter, beleuchtet	775602 € 25,55 [21]	Kontrollwippe mit eingesetztem Fenster inkl. Piktogrammscheibe mit 4 Symbolen (neutral, rot, Licht, Glocke) 					
Aus-/Wechselschalter, beleuchtet, 16 A	775609 € 43,10 [21]						
Aus-/Wechselschalter Kontroll	775820 € 25,55 [21]						
Kreuzschalter, beleuchtet	775827 € 27,95 [21]						
Taster Schließer, beleuchtet	775813 € 18,20 [21]						
Taster Schließer Kontroll	775817 € 22,25 [21]						
Taster Wechsler, beleuchtet	775846 € 18,90 [21]						
Set mit 8 Piktogrammscheiben für Kontrollwippen Einsetzen in Kontrollwippe Best.Nr. 77xx11			775800 € 4,61 [21]				
Aus-/Wechselschalter	775806 € 9,99 [21]	Wippe mit Symbol Lampe 					
Kreuzschalter	775807 € 20,15 [21]						
Taster Schließer	775811 € 11,35 [21]						
Universaltaster Wechsler	775816 € 11,85 [21]						
Wechselschalter, 16 A	775606 € 36,65 [21]						
Aus-/Wechselschalter	775806 € 9,99 [21]	Wippe mit Symbol Glocke 					
Kreuzschalter	775807 € 20,15 [21]						
Taster Schließer	775811 € 11,35 [21]						
Universaltaster Wechsler	775816 € 11,85 [21]						
Wechselschalter, 16 A	775606 € 36,65 [21]						











Schalterprogramm Galea™ Life

Wippen

Funktion	 Geeignet für Einsatz	 Symbol	Farbauswahl								
			Ultraweiß 	Dark Bronze 	Soft Aluminium 	Titanium 	Perlmutter 				
WIPPEN FÜR KOMBINATIONSMONTAGE Gegenplatte bereits auf Wippe vormontiert (Fortsetzung)											
Aus-/Wechselschalter	775806 € 9,99 [21]	Wippe mit Symbol Treppe 									
Kreuzschalter	775807 € 20,15 [21]										
Taster Schließer	775811 € 11,35 [21]						777048 € 8,29 [21]	771248 € 9,36 [22]	771348 € 9,36 [22]	771448 € 9,36 [22]	771548 € 9,36 [22]
Universaltaster Wechsler	775816 € 11,85 [21]										
Wechselschalter, 16 A	775606 € 36,65 [21]										
Aus-/Wechselschalter, beleuchtet	775602 € 25,55 [21]	Kontrollwippe mit fühlbarem Piktogramm Licht („Barrierefreies Wohnen“) 									
Aus-/Wechselschalter Kontroll	775820 € 25,55 [21]										
Kreuzschalter, beleuchtet	775827 € 27,95 [21]						771010 € 13,60 [21]	–	–	–	–
Taster Schließer, beleuchtet	775813 € 18,20 [21]										
Taster Schließer Kontroll	775817 € 22,25 [21]										
Taster Wechsler, beleuchtet	775846 € 18,90 [21]										
Aus-/Wechselschalter, beleuchtet, 16 A	775609 € 43,10 [21]										











Schalterprogramm Galea™ Life

Wippen

Funktion	 Geeignet für Einsatz	 Symbol	Farbauswahl				
			Ultraweiß 	Dark Bronze 	Soft Aluminium 	Titanium 	Perlmutter 
WIPPEN FÜR KOMBINATIONSMONTAGE , Gegenplatte bereits auf Wippe vormontiert (Fortsetzung)							
Aus-/Wechselschalter, beleuchtet	775602 € 25,55 [21]	Kontrollwippe mit fühlbarem Piktogramm Tür („Barrierefreies Wohnen“) 	771011 € 13,60 [21]	-	-	-	
Aus-/Wechselschalter Kontroll	775820 € 25,55 [21]						
Kreuzschalter, beleuchtet	775827 € 27,95 [21]						
Taster Schließer, beleuchtet	775813 € 18,20 [21]						
Taster Schließer Kontroll	775817 € 22,25 [21]						
Taster Wechsler, beleuchtet	775846 € 18,90 [21]						
Aus-/Wechselschalter, beleuchtet, 16 A	775609 € 43,10 [21]						
Aus-/Wechselschalter, beleuchtet	775602 € 25,55 [21]	Kontrollwippe mit fühlbarem Piktogramm Glocke („Barrierefreies Wohnen“) 	771012 € 13,60 [21]	-	-	-	
Aus-/Wechselschalter Kontroll	775820 € 25,55 [21]						
Kreuzschalter, beleuchtet	775827 € 27,95 [21]						
Taster Schließer, beleuchtet	775813 € 18,20 [21]						
Taster Schließer Kontroll	775817 € 22,25 [21]						
Taster Wechsler, beleuchtet	775846 € 18,90 [21]						
Aus-/Wechselschalter, beleuchtet, 16 A	775609 € 43,10 [21]						
Serienschalter	775805 € 15,50 [21]	Serienwippe Neutral 	777012 € 10,25 [21]	771212 € 12,10 [22]	771312 € 12,10 [22]	771412 € 12,10 [22]	771512 € 12,10 [22]
Doppelwechselschalter	775808 € 26,45 [21]						
Doppeltaster 2 Wechsler	775818 € 27,05 [21]						
Taster Wechsler/Wechselschalter	775810 € 28,25 [21]						















Schalterprogramm Galea™ Life

Wippen

Funktion	 Geeignet für Einsatz	 Symbol	Farbauswahl								
			Ultraweiß 	Dark Bronze 	Soft Aluminium 	Titanium 	Perlmutter 				
WIPPEN FÜR KOMBINATIONSMONTAGE , Gegenplatte bereits auf Wippe vormontiert (Fortsetzung)											
Serienschalter, beleuchtet	775825 € 33,85 [21]	Serienschalter beleuchtet mit eingesetztem Fenster 									
Serienschalter Kontroll	775869 € 46,20 [21]						771079 € 12,00 [21]	771279 € 13,55 [22]	771379 € 13,55 [22]	771479 € 13,55 [22]	771579 € 13,55 [22]
Doppelwechschler, beleuchtet	775608 € 38,40 [21]										
Jalousieschalter	775804 € 27,65 [21]	Jalousiewippe mit aufgedruckten Preissymbolen 									
Jalousietaster	775814 € 27,25 [21]						777014 € 14,65 [21]	771214 € 16,95 [22]	771314 € 16,95 [22]	771414 € 16,95 [22]	771514 € 16,95 [22]
Aus-/Wechselschalter	775806 € 9,99 [21]	Wippe mit Beschriftungsfeld, geliefert mit Beschriftungsetiketten 									
Kreuzschalter	775807 € 20,15 [21]						777017 € 11,65 [21]	771217 € 13,45 [22]	771317 € 13,45 [22]	771417 € 13,45 [22]	771517 € 13,45 [22]
Taster Schließer	775811 € 11,35 [21]										
Universaltaster Wechsler	775816 € 11,85 [21]										
Wechselschalter, 16 A	775606 € 36,65 [21]										
Ausschalter, 2-polig	775802 € 21,80 [21]										
Ausschalter, 3-polig	775803 € 37,65 [21]	Wippe mit Aufdruck 0/I 	777015 € 8,34 [21]	771215 € 9,55 [22]	771315 € 9,55 [22]	771415 € 9,55 [22]	771515 € 9,55 [22]				

Schalterprogramm Galea™ Life













Wippen/Steckdosen

Funktion	 Geeignet für Einsatz	 Symbol	Farbauswahl				
			Ultraweiß 	Dark Bronze 	Soft Aluminium 	Titanium 	Perlmutter 
WIPPEN FÜR KOMBINATIONSMONTAGE , Gegenplatte bereits auf Wippe vormontiert (Fortsetzung)							
Ausschalter, 2-polig, Kontroll/beleuchtet	775822 € 34,35 [21]	Wippe Kontroll mit Aufdruck 0/I und eingesetztem transparentem Fenster 	777018 € 10,20 [21]	771218 € 11,80 [22]	771318 € 11,80 [22]	771418 € 11,80 [22]	771518 € 11,80 [22]
Ausschalter, 2-polig, Kontroll/beleuchtet	775822 € 34,35 [21]	Wippe Kontroll Rot mit Aufdruck 0/I und „Heizung Notschalter“ 	771018 € 13,00 [21]	–	–	–	–
Set mit 8 Piktogrammscheiben für Kontrollwippen Einsetzen in Kontrollwippe Best.Nr. 77xx11			775800 € 4,61 [21]				
SCHUTZKONTAKT-STECKDOSEN, 16 A/250 V~ FÜR KOMBINATIONSMONTAGE Einsatz mit Abdeckung 53 x 65 mm, für Spreiz- und Schraubbefestigung, Anschlüsse mit schraublosen Verbindungsklemmen (SL) oder Schraubklemmen (SK), geeignet für den Anschluss von starren und flexiblen Leitern							
Steckdose (SL)			771062 ⁽¹⁾ € 10,05 [21]	771262 ⁽¹⁾ € 13,45 [22]	771362 ⁽¹⁾ € 13,45 [22]	771462 ⁽¹⁾ € 13,45 [22]	771562 ⁽¹⁾ € 13,45 [22]
Steckdose (SL) mit erhöhtem Berührungsschutz			771063 ⁽¹⁾ € 13,55 [21]	771263 ⁽¹⁾ € 16,35 [22]	771363 ⁽¹⁾ € 16,35 [22]	771463 ⁽¹⁾ € 16,35 [22]	771563 ⁽¹⁾ € 16,35 [22]
Steckdose (SL) mit Klappdeckel und erhöhtem Berührungsschutz Flacher Klappdeckel			771064 ⁽¹⁾ € 18,10 [21]	771264 ⁽¹⁾ € 21,60 [22]	771364 ⁽¹⁾ € 21,60 [22]	771464 ⁽¹⁾ € 21,60 [22]	771564 ⁽¹⁾ € 21,60 [22]
Steckdose (SK) mit Kontrolllampe und erhöhtem Berührungsschutz Kontrolllampe Orange leuchtend, geliefert mit Beschriftungsetiketten			771048 ⁽¹⁾ € 34,10 [21]	–	–	–	–
BESCHRIFTUNGSTRÄGER FÜR GALEA™ LIFE							
Selbstklebender Beschriftungsträger Für vertikale und horizontale Kunststoffrahmen			771100 € 4,88 [21]				

1: inkl. Einsatz

Schalterprogramm Galea™ Life

Steckdosen

Funktion	 Geeignet für Einsatz	 Symbol	Farbauswahl				
			Ultraweiß 	Dark Bronze 	Soft Aluminium 	Titanium 	Perlmutter 
SCHUTZKONTAKT-STECKDOSEN, 16 A/250 V~ FÜR WSV, SV, ZSV UND USV Zur Kennzeichnung bestimmter Stromkreise: WSV: Weitere Sicherheits-Stromversorgung, SV: Sicherheits-Stromversorgung, ZSV: Zusätzliche Sicherheits-Stromversorgung, USV: Unterbrechungsfreie Sicherheits-Stromversorgung							
Steckdose (SK) Orange mit Kontrolllampe und erhöhtem Berührungsschutz Für zusätzliche Sicherheits-Stromversorgung (ZSV)	–					771045 ⁽¹⁾ € 35,45 [22]	
Steckdose (SK) Rot mit Kontrolllampe und erhöhtem Berührungsschutz Für weitere Sicherheits-Stromversorgung (WSV)	–					771046 ⁽¹⁾ € 35,45 [22]	
Steckdose (SK) Gelb mit Kontrolllampe und erhöhtem Berührungsschutz Für unterbrechungsfreie Sicherheits-Stromversorgung (USV)	–					771047 ⁽¹⁾ € 31,95 [22]	
Steckdose (SK) Grün mit Kontrolllampe und erhöhtem Berührungsschutz Für Sicherheits-Stromversorgung (SV)	–					771044 ⁽¹⁾ € 35,45 [22]	
SCHUTZKONTAKT-STECKDOSE, 16 A/250 V~ VERWECHSLUNGSSICHER							
Steckdose (SK) Rot, verwechslungssicher	–					771029 ⁽¹⁾ € 38,10 [22]	
Ersatz-Codierplättchen Für verwechslungssichere Steckdosen, zum Aufkleben auf die zu codierenden Stecker	–					050299 € 5,34 [43]	

1: inkl. Einsatz

Schalterprogramm Galea™ Life

Abdeckungen für Dimmer, Bewegungsmelder, Elektronische Schalter

Funktion	 Geeignet für Einsatz	 Symbol	Farbauswahl				
			Ultraweiß 	Dark Bronze 	Soft Aluminium 	Titanium 	Perlmutter 
DREHDIMMER							
Drehdimmer 40 – 400 W, Phasenanschnitt	775654 € 44,00 [31]		771068 € 15,60 [21]	771268 € 20,35 [22]	771368 € 20,35 [22]	771468 € 20,35 [22]	771568 € 20,35 [22]
Elektronischer Tastpotentiometer	078404 € 136,45 [29]		771067 € 9,51 [21] + 0391F6500 € 2,30 [21]	-	-	-	-
Druck-Wechseldimmer, 1000 W, Phasenabschnitt	775910 € 239,70 [31]		777059 € 34,05 [21]	-	-	771459 € 38,95 [22]	771559 € 38,95 [22]
TASTDIMMER UND BEWEGUNGSMELDER							
Universal-Tastdimmer, 400 W, Phasen-/abschnitt	775652 € 175,00 [31]						
Tastdimmer Phasenanschnitt, 600 W, Phasenabschnitt	775653 € 83,25 [31]		771086 € 16,50 [21]	771286 € 21,50 [22]	771386 € 21,50 [22]	771486 € 21,50 [22]	771586 € 21,50 [22]
LED-Tastdimmer, 400 W, ohne Neutralleiter, Phasen-/abschnitt	775659 € 128,45 [31]						
BEWEGUNGSMELDER PRO 21™/GALEA™ mit Schraubklemmen, geeignet für Spreizkrallen- und Schraubbefestigung							
Bewegungsmelder 2-Leiter 180°, mit/ohne Handschalter, parallelschaltbar	-		A77102 ⁽¹⁾ € 192,15 [31]	-	-	-	-
Bewegungsmelder 3-Leiter 180°, mit/ohne Handschalter, parallelschaltbar, Nebenstelleneingang	-		A77103 ⁽¹⁾ € 159,95 [31]	-	-	-	-
Bewegungsmelder 3-Leiter ohne Handbetätigung, 120°⁽²⁾	-		775673 ⁽¹⁾ € 57,55 [31] + 999878 ⁽¹⁾ € 18,60 [21]	775673 € 57,55 [31] + 999879 ⁽¹⁾ € 18,60 [21]	775673 € 57,55 [31] + 999880 ⁽¹⁾ € 18,60 [21]	775673 € 57,55 [31] + 999881 ⁽¹⁾ € 18,60 [21]	
Bewegungsmelder 2-Leiter mit Handbetätigung, 120°⁽³⁾	-		775672 ⁽¹⁾ € 139,85 [31] + 999874 ⁽¹⁾ € 17,90 [21]	775672 € 139,85 [31] + 999875 ⁽¹⁾ € 17,90 [21]	775672 € 139,85 [31] + 999876 ⁽¹⁾ € 17,90 [21]	775672 € 139,85 [31] + 999877 ⁽¹⁾ € 17,90 [21]	

1: inkl. Einsatz

2: Für folgende Lastarten geeignet:

- Glüh- und HV-Halogenlampen: 3 - 250 W

- LEDs, Leuchtstoff- und Kompaktleuchtstofflampen und NV-Halogenlampen mit elektronischem oder konventionellem Vorschaltgerät: 3 - 250 VA

- LED- oder Kompaktleuchtstofflampen: 3 - 100 W, Parallelschaltung mehrerer Bewegungsmelder möglich, (max. 2 zusätzliche Sensoren).

Die Einstellungen werden mittels Potentiometer durchgeführt.

3: Für folgende Lastarten geeignet:

- Glüh- und HV-Halogenlampen: bis 400 W

- LEDs, Leuchtstoff- und Kompaktleuchtstofflampen und NV-Halogenlampen mit elektronischem oder konventionellem Vorschaltgerät: bis 200 VA









- LED- oder Kompaktleuchtstofflampen: bis 50 W, Parallelschaltung mehrerer Bewegungsmelder möglich.

Die Einstellungen werden mittels Potentiometer durchgeführt.

4: Lieferzeit auf Anfrage.

Schalterprogramm Galea™ Life











Wippen & Abdeckungen

Funktion	 Geeignet für Einsatz	 Symbol	Farbauswahl				
			Ultraweiß	Dark Bronze	Soft Aluminium	Titanium	Perlmutter
FERNSCHALTER							
Fernschalter Doseneinbau	049120 € 63,45 [43]		-	-	-	-	-
ANTENNE AUSFÜHRUNG HIRSCHMANN							
Abdeckung Antennen-Steckdose 3-Loch	775983 € 31,65 [21]		771089 € 9,95 [21]	771289 € 11,30 [22]	771389 € 11,30 [22]	771489 € 11,30 [22]	771589 € 11,30 [22]
Abdeckung für Antennen-Steckdose 2-Loch	775981 € 26,45 [21]		777083 € 9,99 [21]	771283 € 11,30 [22]	771383 € 11,30 [22]	771483 € 11,30 [22]	771583 € 11,30 [22]
	775984 € 29,05 [21]						
ANTENNE AUSFÜHRUNG LEGRAND							
TV Einzeldose	775786 € 23,50 [21]	TV-R, 2-Loch 	771072 € 11,15 [21]	771272 € 12,55 [22]	771372 € 12,55 [22]	771472 € 12,55 [22]	771572 € 12,55 [22]
TV Enddose	775787 € 23,50 [21]						
TV Durchgangsdose	775788 € 23,50 [21]						
TV Einzeldose	775789 € 26,35 [21]	TV-R-SAT, 3-Loch 	771073 € 11,15 [21]	771273 € 12,55 [22]	771373 € 12,55 [22]	771473 € 12,55 [22]	771573 € 12,55 [22]
TV Enddose	775790 € 26,35 [21]						
TV Durchgangsdose	775791 € 26,35 [21]						
TELEFON							
Abdeckung TDO für Telefon-Steckdose Österreich	775990 € 48,75 [21]		771147 € 9,36 [21]	771247 € 10,75 [22]	771347 € 10,75 [22]	771447 € 10,75 [22]	771547 € 10,75 [22]
Abdeckung TAE für Telefon-Steckdose Deutschland	775991 € 14,85 [21]		771042 € 9,37 [21]	771242 € 10,80 [22]	771342 € 10,80 [22]	771442 € 10,80 [22]	771542 € 10,80 [22]

1: Lieferzeit auf Anfrage









Schalterprogramm Galea™ Life

Abdeckungen

Funktion	 Geeignet für Einsatz	 Symbol	Farbauswahl				
			Ultraweiß 	Dark Bronze 	Soft Aluminium 	Titanium 	Perlmutter 
DATENANSCHLUSSTECHNIK							
TAE 1 x RJ45	–	Auslass 30° mit Beschriftungsträger 	777095 € 11,75 [21]	771295 € 13,55 [22]	771395 € 13,55 [22]	771495 € 13,55 [22]	771595 € 13,55 [22]
DAE UTP 1 x RJ45, Kategorie 5e	775761 € 25,65 [21]	Auslass 30° mit Beschriftungsträger 					
DAE UTP 2 x RJ45, Kategorie 5e	775762 € 33,30 [21]						
DAE UTP 1 x RJ45, Kategorie 6	775828 € 27,15 [31]						
DAE UTP 2 x RJ45, Kategorie 6	775830 € 36,55 [31]						
DAE FSTP 1 x RJ45, Kategorie 6	775767 € 31,75 [21]						
DAE FSTP 2 x RJ45, Kategorie 6	775768 € 41,30 [21]						
DATENDOSE SYSTEM LSA-PLUS Fabrikat Rutenbeck, BTR, Telegärtner							
DAE FSTP 2 x RJ45, Kategorie 5e	775887 € 43,95 [31]		771058 € 9,01 [21]	771258 € 11,65 [22]	771358 € 11,65 [22]	771458 € 11,65 [22]	771558 € 11,65 [22]
DAE FSTP 2 x RJ45, Kategorie 6A	775976 € 42,10 [31]						

Schalterprogramm Galea™ Life









Abdeckungen

Funktion	 Geeignet für Einsatz	 Symbol	Farbauswahl									
			Ultraweiß 	Dark Bronze 	Soft Aluminium 	Titanium 	Perlmutter 					
UNIVERSAL-ABDECKUNG												
Drucktaster Ultraweiß	775844 € 29,70 [21]	Abdeckung mit Ausnehmung Ø 46,5 mm 										
Zugschalter	775809 € 29,00 [21]											
Zugtaster	775819 € 29,00 [21]											
Lichtsignal	775940 € 27,85 [21]											
Potentialausgleichssteckdose	775988 € 46,90 [21]											
Summer Ultraweiß, 230 V~	775712 € 33,85 [31]							777019 € 9,51 [21]	771219 € 10,85 [22]	771319 € 10,85 [22]	771419 € 10,85 [22]	771519 € 10,85 [22]
Rollladenschaltuhr Ultraweiß	775746 € 163,25 [31]											
Rollladenschaltuhr Dark Bronze	775696 € 195,60 [31]											
Rollladenschaltuhr Soft Aluminium	775697 € 195,60 [31]											
Rollladenschaltuhr Titanium	775698 € 195,60 [31]											
Rollladenschaltuhr Perlmutter	775699 € 195,60 [31]											
Gong 12 V~	A75111 € 83,65 [16]		A01802 € 2,29 [21]	-								
Gong 230 V~	A75112 € 86,30 [16]											

1: Lieferzeit auf Anfrage













Schalterprogramm Galea™ Life

Abdeckungen

Funktion	 Geeignet für Einsatz	 Symbol	Farbauswahl				
			Ultraweiß 	Dark Bronze 	Soft Aluminium 	Titanium 	Perlmutter 
UNIVERSAL-ABDECKUNG							
Raumthermostat Standard Ultraweiß	775815 € 134,85 [31]						
Raumthermostat Standard Dark Bronze	775684 € 150,30 [31]						
Raumthermostat Standard Soft Aluminium	775685 € 150,30 [31]						
Raumthermostat Standard Titanium	775686 € 150,30 [31]						
Raumthermostat Standard Perlmutter	775687 € 150,30 [31]						
Raumthermostat Komfort Ultraweiß	775867 € 142,45 [31]						
Raumthermostat Komfort Dark Bronze	775692 € 156,65 [31]	Abdeckung mit Ausnehmung Ø 46,5 mm 	777019 € 9,51 [21]	771219 € 10,85 [22]	771319 € 10,85 [22]	771419 € 10,85 [22]	771519 € 10,85 [22]
Raumthermostat Komfort Soft Aluminium	775693 € 156,65 [31]						
Raumthermostat Komfort Titanium	775694 € 156,65 [31]						
Raumthermostat Fußbodenheizung Ultraweiß	775858 € 223,50 [31]						
Raumthermostat Fußbodenheizung Dark Bronze	775688 € 230,90 [31]						
Raumthermostat Fußbodenheizung Soft Aluminium	775689 € 230,90 [31]						
Raumthermostat Fußbodenheizung Titanium	775690 € 230,90 [31]						
Raumthermostat Fußbodenheizung Perlmutter	775691 € 230,90 [31]						















Schalterprogramm Galea™ Life

Abdeckungen

Funktion	 Geeignet für Einsatz	 Symbol	Farbauswahl				
			Ultraweiß 	Dark Bronze 	Soft Aluminium 	Titanium 	Perlmutter 
DREH- UND ZEITSCHALTER							
Zeitschalter 0 – 15 Min.	775962 € 85,95 [21]	Abdeckung mit Knebelknopf 					
Zeitschalter 0 – 120 Min.	775964 € 91,75 [21]						
Stufenschalter Jalousie	775853 € 44,20 [21]						
3-Stufenschalter ohne Nullstellung	775957 € 70,50 [21]						
3-Stufenschalter mit Nullstellung	775958 € 76,20 [21]						
1-Stufenschalter mit Nullstellung	775959 € 59,70 [21]						
LEITUNGS AUSLASS							
Leitungsauslass mit Klemmen	775985 € 12,70 [21]		777085 € 9,61 [21]	771285 € 12,00 [22]	771385 € 12,00 [22]	771485 € 12,00 [22]	771585 € 12,00 [22]
Leitungsauslass ohne Klemmen	775986 € 10,45 [21]						
BLINDABDECKUNG							
Blindabdeckung mit Tragring	–		777078 € 13,85 [21]	771278 € 18,55 [22]	771378 € 18,55 [22]	771478 € 18,55 [22]	771578 € 18,55 [22]
HI-FI LAUTSPRECHER-ANSCHLUSSEINHEIT							
Abdeckung für Anschlusseinheit 1-fach	775785 € 16,95 [31]		771000 € 12,05 [21]	771200 € 13,90 [22]	771300 € 13,90 [22]	771400 € 13,90 [22]	771500 € 13,90 [22]
Abdeckung für Anschlusseinheit 2-fach	775784 € 21,35 [31]		771025 € 12,60 [21]	771225 € 14,55 [22]	771325 € 14,55 [22]	771425 € 14,55 [22]	771525 € 14,55 [22]

Schalterprogramm Galea™ Life













Abdeckungen

Funktion	 Geeignet für Einsatz	 Symbol	Farbauswahl				
			Ultraweiß 	Dark Bronze 	Soft Aluminium 	Titanium 	Perlmutter 
HOTEL-CARD							
Hotel-Card	775954 € 41,85 [21]	Abdeckung für mechanischen Hotel-Card-Schalter 	777054 € 38,65 [21]	771254 € 48,25 [22]	771354 € 48,25 [22]	771454 € 48,25 [22]	771554 € 48,25 [22]
ADAPTER 45 × 45							
Zwischenrahmen für Sondergeräte 45 × 45 Geeignet für Einbaugeräte mit Abdeckung 45 × 45 mm	–		771067 € 9,51 [21]	771267 € 10,90 [22]	771367 € 10,90 [22]	771467 € 10,90 [22]	771567 € 10,90 [22]
ADAPTER 50 × 50							
Zwischenrahmen für Sondergeräte 50 x 50 Geeignet für Einbaugeräte mit Abdeckung 50 × 50 mm	–		771099 € 5,16 [21]	771299 € 6,42 [22]	771399 € 6,42 [22]	771499 € 6,42 [22]	771599 € 6,42 [22]
SOUND-SYSTEM MEHRRaum-LÖSUNG							
Lautsprecher „Spot“ Ø 100 mm Einbaulautsprecher 20 W, 8 Ω Abmessung: Ø 80 mm, Farbe Ultraweiß	–		573982 € 43,25 [15]				
STECKDOSE BRITISCHER STANDARD							
Abdeckung für Steckdose mit erhöhtem Berührungsschutz, abschaltbar Einsatz 2 P + E, 13 A/250 V~	775848 € 51,15 [21]		777096 € 12,45 [21]	771296 € 15,00 [22]	771396 € 15,00 [22]	771496 € 15,00 [22]	771596 € 15,00 [22]
AUFPUTZ-GEHÄUSE Für horizontale Montage (nicht geeignet für DIN-Profileinsätze)							
Aufputz-Gehäuse 1-fach 88 × 96 mm (Außenmaß)	–		771096 € 14,35 [21]	–	–	–	–
Aufputz-Gehäuse 2-fach 88 × 167 mm (Außenmaß)	–		771097 € 28,40 [21]	–	–	–	–
Aufputz-Gehäuse 3-fach 88 × 238 mm (Außenmaß)	–		771098 € 44,95 [21]	–	–	–	–

*Bezieht sich ausschließlich auf Ultraweiß

Schalterprogramm Galea™ Life

Feuchtraum Unterputz IP 44













Funktion	 Geeignet für Einsatz	 Symbol	Farbauswahl				
			Ultraweiß 	Dark Bronze 	Soft Aluminium 	Titanium 	Perlmutter 
WIPPSCHALTER, 10 A/250 V~ (ZUR VERWENDUNG MIT STANDARDRAHMEN)							
Einsatz Universal Aus-/Wechselschalter 1-polig mit Wippe			771020 ⁽¹⁾⁽²⁾ € 30,90 [24]				
Einsatz Serienschalter mit Wippe			771021 ⁽¹⁾⁽²⁾ € 39,50 [24]				
Einsatz Doppelwechselschalter mit Wippe			771022 ⁽¹⁾⁽²⁾ € 49,15 [24]				
Einsatz Kreuzschalter mit Wippe			771024 ⁽¹⁾⁽²⁾ € 40,90 [24]				
Einsatz Taster Schließer 1-polig mit Wippe			771023 ⁽¹⁾⁽²⁾ € 34,25 [24]				
FEUCHTRAUM-DICHTUNGSSETS (ZUR VERWENDUNG MIT STANDARDRAHMEN)							
FR-Wippe mit Beleuchtungsfenster + Dichtungstopf Als Abdeckung für Pro 21 Schalter und Taster		ohne Abb.	771150 € 27,95 [24]				
FR-Jalousiewippe + Dichtungstopf Als Abdeckung für Pro 21 Jalousieschalter und -taster		ohne Abb.	771153 € 26,85 [24]				
SCHUTZKONTAKT-STECKDOSE, 16 A/250 V~ (ZUR VERWENDUNG MIT STANDARDRAHMEN)							
Schutzkontakt-Steckdose (SL) mit Klappdeckel und erhöhtem Berührungsschutz			771027 ⁽¹⁾⁽²⁾ € 27,95 [24]				

1: inkl. Einsatz

2: Für die IP 44-Einsätze werden die Standard-Abdeckrahmen zur Komplettierung verwendet.

Creo™ und Galea™ Life

Glimmaggregate, Glimmlampen, Montagezubehör

Funktion	Best.Nr.	Geeignet für Schalterserie:	
		Creo™ 	Galea™ Life 
GLIMMAGGREGATE MIT KONTAKTKASSETTE (ZUM NACHTRÄGLICHEN BELEUCHTEN DES EINSATZES)			
Glimmaggregat 230 V~/0,5 mA Grün leuchtend, für beleuchtete Funktionen 	775894 € 6,85 [21]	●	●
Glimmaggregat 230 V~/1 mA nur für Taster geeignet Grün leuchtend, für beleuchtete Funktionen (erhöhte Helligkeitsanforderungen) 	775893 € 7,34 [21]	●	●
Glimmaggregat 230 V~/0,5 mA Orange leuchtend, für Kontroll-Funktionen 	775895 € 7,34 [21]	●	●
Glimmaggregat 8-12 V~/15 mA Grün leuchtend, für beleuchtete Funktionen 	775896 € 7,99 [21]	●	●
ERSATZGLIMMLAMPEN			
Glimmlampe 230 V~/0,5 mA Grün leuchtend 	775897 € 3,98 [21]	●	●
Glimmlampe 230 V~/1 mA nur für Taster geeignet Grün leuchtend 	775890 € 4,25 [21]	●	●
Glimmlampe 230 V~/1 mA Orange leuchtend 	775898 € 4,25 [21]	●	●
Glimmlampe 8-12 V~/15 mA Grün leuchtend 	775899 € 6,41 [21]	●	●
MONTAGEZUBEHÖR			
Befestigungsschrauben 3 x 16 mm 1 Verpackungseinheit = 200 Schrauben (Preis pro Stk.)	067829 € 8,17 [21]	●	●
Spreizkrallenverlängerung 18 mm Für Wippschalter, -taster und Steckdosen 	775949 € 1,51 [21]	●	●
Schutzabdeckung für UP-Einsätze 	775900 € 1,03 [21]	●	●

Niloé™ Step

MODERN. FUNKTIONELL.
WIRTSCHAFTLICH.

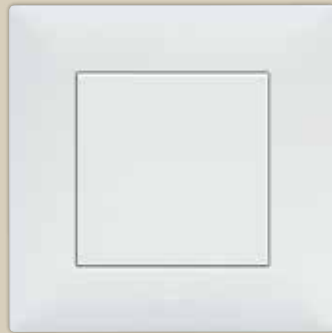

Ultraweiß



Sand



Aluminium



Schwarz

FÜNF VORTEILE, DIE SIE ÜBERZEUGEN WERDEN!



+ ELEGANT

Formen und Ausführungen

- Quadratisch
- Schlank und elegant
- 4 Rahmenfarben
- 4 Wippenfarben
- Schraublos
- Schutzabdeckung
- ...

+ MODERN

Funktionen und Ästhetik

- 4 moderne Trendfarben
- Innovative Produkte, wie z. B. Wireless Charging, Energiesparschalter, USB-Ladesteckdose
- ...

+ SICHER

Immer sicher

- erhöhter Berührungsschutz, standardmäßig in den Steckdosen integriert
- Isolierter Tragring: Maximaler Berührungsschutz vor Stromschlag und Verletzungen
- Isolierte Kontakte gegen unbeabsichtigtes Berühren von spannungsführenden Teilen ...

+ EINFACH























Schnelle und einfache Installation

- Zeitsparende und werkzeuglose Montage durch Rastsystem
- Präzise automatische Klemmen garantieren eine lebenslange Verbindung
- Effiziente Installation von Mehrfachkombinationen durch flexible Führungssysteme an den Tragringen ...

+ PROFITABEL

Wirtschaftlich und effizient





















- Verringerung der Installationszeit durch das Rast- und Führungssystem bei Mehrfachkombinationen
- Schutzabdeckungen schützen den Einsatz vor Beschädigungen und Verschmutzungen und Sie von Reklamations- und Austauschkosten ...

Funktion	EINSÄTZE	NILOÉ STEP ABDECKUNGEN			
		Ultraweiß 	Aluminium 	Schwarz 	Sand 
SCHALTER 10 AX–250 V~					
Wechselschalter 	864006 € 8,13 [26]	864101 € 3,83 [26]	864301 € 5,21 [26]	864501 € 3,48 [26]	864601 € 3,83 [26]
Wechselschalter, beleuchtet 	864006 + 764526 € 8,13 + € 4,17 [26] [26]	864106 € 4,94 [26]	864306 € 7,43 [26]	864506 € 4,94 [26]	864606 € 4,94 [26]
Wechselschalter, Kontroll 	864006 + 764521 € 8,13 + € 4,17 [26] [26]	864106 € 4,94 [26]	864306 € 7,43 [26]	864506 € 4,94 [26]	864606 € 4,94 [26]
Wechselschalter, IP 44 	–	864133 ⁽¹⁾⁽²⁾ € 19,30 [26]	–	–	–
Energiesparschalter 	864009 € 58,60 [27]	864109 € 4,16 [26]	864309 € 6,24 [26]	864509 € 4,16 [26]	864609 € 4,16 [26]
Kreuzschalter 	864007 € 14,50 [26]	864107 € 6,57 [26]	864307 € 9,28 [26]	864507 € 6,57 [26]	864607 € 6,57 [26]
Mechanischer Hotel-Card-Schalter 	864015 € 31,20 [27]	864115 € 27,35 [26]	864315 € 31,85 [26]	864515 € 27,35 [26]	864615 € 27,35 [26]
Serienschalter 	864005 € 13,00 [26]	864105 € 5,55 [26]	864305 € 8,34 [26]	864505 € 5,55 [26]	864605 € 5,55 [26]
Serienschalter, beleuchtet 	864005 + 2 x 764526 € 13,00 + 2 x € 4,17 [26] [26]	864108 € 7,16 [26]	864308 € 10,75 [26]	864508 € 7,16 [26]	864608 € 7,16 [26]
Serienschalter, Kontroll 	864005 + 2 x 764521 € 13,00 + 2 x € 4,17 [26] [26]	864108 € 7,16 [26]	864308 € 10,75 [26]	864508 € 7,16 [26]	864608 € 7,16 [26]
Doppelwechselschalter 	864008 € 12,00 [26]	864105 € 5,55 [26]	864305 € 8,34 [26]	864505 € 5,55 [26]	864605 € 5,55 [26]
Doppelwechselschalter, beleuchtet 	864008 + 2 x 764526 € 12,00 + 2 x € 4,17 [26] [26]	864108 € 7,16 [26]	864308 € 10,75 [26]	864508 € 7,16 [26]	864608 € 7,16 [26]
Doppelwechselschalter, Kontroll 	864008 + 2 x 764521 € 12,00 + 2 x € 4,17 [26] [26]	864108 € 7,16 [26]	864308 € 10,75 [26]	864508 € 7,16 [26]	864608 € 7,16 [26]
3-fach Ausschalter 	864003 € 12,60 [26]	864103 € 5,40 [26]	864303 € 8,12 [26]	864503 € 5,40 [26]	864603 € 5,40 [26]
SCHALTER 16 AX–250 V~					
Wechselschalter 	864016 € 16,00 [26]	864101 € 3,83 [26]	864301 € 5,21 [26]	864501 € 3,48 [26]	864601 € 3,83 [26]
Wechselschalter, beleuchtet 	864016 + 764526 € 16,00 + € 4,17 [26] [26]	864106 € 4,94 [26]	864306 € 7,43 [26]	864506 € 4,94 [26]	864606 € 4,94 [26]
Wechselschalter, Kontroll 	864016 + 764521 € 16,00 + € 4,17 [26] [26]	864106 € 4,94 [26]	864306 € 7,43 [26]	864506 € 4,94 [26]	864606 € 4,94 [26]
SCHALTER 20 AX–250 V~					
2-poliger Wechselschalter 	077063L € 18,20 [29]	864179 € 9,25 [26]	–	–	–
2-poliger Wechselschalter Kontroll 	077063L + 067664 € 18,20 + € 8,67 [29] [14]	864179 € 9,25 [26]	–	–	–

1: inkl. Einsatz, 2: Für die IP 44-Einsätze werden die Standard-Abdeckrahmen zur Komplettierung verwendet.





















Niloe™ Step

Auswahltabelle Abdeckungen

Funktion	EINSÄTZE	NILOÉ STEP ABDECKUNGEN			
		Ultraweiß 	Aluminium 	Schwarz 	Sand 
SCHALTER 2-POLIG, 10 AX–250 V~					
2-poliger Ausschalter 	864028 € 15,25 [26]	864107 € 6,57 [26]	864307 € 9,28 [26]	864507 € 6,57 [26]	864607 € 6,57 [26]
2-poliger Ausschalter, beleuchtet 	864029 € 18,65 [26]	864114 € 5,20 [26]	864314 € 7,81 [26]	864514 € 5,20 [26]	864614 € 5,20 [26]
2-poliger Ausschalter, Kontroll 	864028 + 764521 € 15,25 + € 4,17 [26] [26]	864114 € 5,20 [26]	864314 € 7,81 [26]	864514 € 5,20 [26]	864614 € 5,20 [26]
2-poliger Ausschalter I/O 	864028 € 15,25 [26]	864102 € 3,78 [26]	864302 € 5,66 [26]	864502 € 3,78 [26]	864602 € 3,99 [26]
2-poliger Ausschalter Kontroll I/O 	864028 + 764521 € 15,25 + € 4,17 [26] [26]	864104 € 5,20 [26]	864304 € 7,81 [26]	864504 € 5,20 [26]	864604 € 5,20 [26]
TASTER 6 A–250 V~					
Taster mit Wechselkontakt 	864011 € 9,15 [26]	864101 € 3,83 [26]	864301 € 5,21 [26]	864501 € 3,48 [26]	864601 € 3,83 [26]
Taster mit Wechselkontakt, beleuchtet 	864011 + 764526 € 9,15 + € 4,17 [26] [26]	864106 € 4,94 [26]	864306 € 7,43 [26]	864506 € 4,94 [26]	864606 € 4,94 [26]
Taster mit Wechselkontakt, beleuchtet mit Beschriftung 	864011 + 764526 € 9,15 + € 4,17 [26] [26]	864111 € 9,16 [26]	864311 € 9,16 [26]	864311 € 9,16 [26]	864111 € 9,16 [26]
Zugtaster mit Wechselkontakt 	–	864113 ⁽¹⁾ € 23,45 [26]	864313 ⁽¹⁾ € 29,25 [26]	864513 ⁽¹⁾ € 23,45 [26]	864613 ⁽¹⁾ € 23,45 [26]
Doppeltaster mit Wechselkontakten 	864012 € 22,90 [26]	864105 € 5,55 [26]	864305 € 8,34 [26]	864505 € 5,55 [26]	864605 € 5,55 [26]
Doppeltaster mit Wechselkontakten, beleuchtet 	864012 + 2 x 764526 € 22,90 + 2 x € 4,17 [26] [26]	864108 € 7,16 [26]	864308 € 10,75 [26]	864508 € 7,16 [26]	864608 € 7,16 [26]
Taster mit Wechselkontakt IP 44 	–	864134 ⁽¹⁾⁽²⁾ € 34,75 [26]	–	–	–
ROLLADENSTEUERUNG					
Rollladenschalter – 6 AX–250 V~ 	864031 € 21,35 [26]	864131 € 9,16 [26]	864331 € 13,70 [26]	864531 € 9,16 [26]	864631 € 9,16 [26]
Rollladentaster – 6 A–250 V~ 	864030 € 22,79 [26]	864130 € 9,60 [26]	864330 € 14,45 [26]	864530 € 9,60 [26]	864630 € 9,60 [26]
BEWEGUNGSMELDER					
Bewegungsmelder, 2-Leiter ohne Handschalter 	864010 € 107,60 [27]	864110 € 7,81 [26]	864310 € 11,70 [26]	864510 € 7,81 [26]	–
Bewegungsmelder, 3-Leiter ohne Handschalter 	864065 € 38,20 [27]				
Bewegungsmelder, 3-Leiter, IP 44 	–	864166 ⁽¹⁾⁽²⁾ € 134,10 [26]	–	–	–

1: inkl. Einsatz

2: Für die IP 44-Einsätze werden die Standard-Abdeckrahmen zur Komplettierung verwendet.

Funktion		EINSÄTZE	NILOÉ STEP ABDECKUNGEN			
			Ultraweiß 	Aluminium 	Schwarz 	Sand 
DIMMER – 240 V~ – 50 HZ						
Universal Drehdimmer 		864017 € 63,30 [27]	864117 € 7,81 [26]	864317 € 11,70 [26]	864517 € 7,81 [26]	864617 € 7,81 [26]
	Universal Tastdimmer 	864018 € 110,45 [27]	864118 € 8,46 [26]	864318 € 12,65 [26]	864518 € 8,46 [26]	–
STECKDOSEN MIT ERHÖHTEM BERÜHRUNGSSCHUTZ – 16 A – 250 V~						
Steckdose 		–	864162 ⁽¹⁾ € 5,75 [26]	864362 ⁽¹⁾ € 8,59 [26]	864562 ⁽¹⁾ € 5,75 [26]	864662 ⁽¹⁾ € 5,75 [26]
	Steckdose mit Klappdeckel 	–	864163 ⁽¹⁾ € 12,25 [26]	864363 ⁽¹⁾ € 18,40 [26]	864563 ⁽¹⁾ € 12,25 [26]	864663 ⁽¹⁾ € 12,25 [26]
Feuchtraum-Steckdose IP 44 	–	–	864135 ⁽¹⁾⁽³⁾ € 18,71 [26]	–	–	863523 ⁽¹⁾ € 17,65 [26]
2-fach Steckdose für 1 Schalterdose 	–	–	864164 ⁽¹⁾ € 12,60 [26]	864364 ⁽¹⁾ € 18,95 [26]	864564 ⁽¹⁾ € 12,60 [26]	864664 ⁽¹⁾ € 12,60 [26]
USB CHARGING LADESTATION						
Steckdose mit integrierter USB-C-Ladeeinheit (für 1-fach Rahmen) 		–	864127 ⁽¹⁾ € 68,95 [26]	864327 ⁽¹⁾ € 73,25 [26]	864527 ⁽¹⁾ € 68,95 [26]	864627 ⁽¹⁾ € 68,95 [26]
	Steckdose mit USB-A-Ladeeinheit 	–	864123 ⁽²⁾ € 76,75 [26]	864323 ⁽²⁾ € 91,60 [26]	864523 ⁽²⁾ € 76,75 [26]	864623 ⁽²⁾ € 76,75 [26]
2-fach USB-A-Ladeeinheit 	864024 € 36,40 [27]	864124 € 5,47 [26]	864324 € 8,19 [26]	864524 € 5,47 [26]	864624 € 5,47 [26]	
Micro-USB-Ladeeinheit 	864024 € 36,40 [27]	864125 € 5,47 [26]	864325 € 8,19 [26]	864525 € 5,47 [26]	864625 € 5,47 [26]	
Wireless Charging Aufladestation 	–	–	864126 ⁽¹⁾ € 97,60 [27]	–	–	–
TV-DOSEN						
Einzeldose	TV-R-SAT Abdeckung 30 mm 	–	864160 € 5,36 [26]	864360 € 7,59 [26]	864560 € 5,36 [26]	864660 € 5,36 [26]
	TV-R-SAT Dose 	864057 € 17,85 [26]	864157 € 7,67 [26]	864357 € 11,50 [26]	864557 € 7,67 [26]	864657 € 7,67 [26]
	TV-SAT Dose 	864054 € 14,40 [26]	864154 € 7,67 [26]	864354 € 11,50 [26]	864554 € 7,67 [26]	864654 € 7,67 [26]
	TV Dose 	864051 € 11,70 [26]	864151 € 7,67 [26]	864351 € 11,50 [26]	864551 € 7,67 [26]	864651 € 7,67 [26]
	Typ „F“ TV Dose 	864050 € 10,40 [26]	864151 € 7,67 [26]	864351 € 11,50 [26]	864551 € 7,67 [26]	864651 € 7,67 [26]



















1: inkl. Einsatz

2: Komplettes Produkt

3: Für die IP 44-Einsätze werden die Standard-Abdeckrahmen zur Komplettierung verwendet.

Niloe™ Step









Auswahltabelle Abdeckungen

Funktion		EINSÄTZE	NILOÉ STEP ABDECKUNGEN			
			Ultraweiß 	Aluminium 	Schwarz 	Sand 
TV-DOSEN						
Durchgangsdose	TV-R-SAT Dose 	864058 € 17,85 [26]	864157 € 7,67 [26]	864357 € 11,50 [26]	864557 € 7,67 [26]	864657 € 7,67 [26]
	TV-SAT Dose 	864055 € 14,40 [26]	864154 € 7,67 [26]	864354 € 11,50 [26]	864554 € 7,67 [26]	864654 € 7,67 [26]
	TV Dose 	864052 € 11,70 [26]	864151 € 7,67 [26]	864351 € 11,50 [26]	864551 € 7,67 [26]	864651 € 7,67 [26]
Enddose	TV-R-SAT Dose 	864059 € 17,85 [26]	864157 € 7,67 [26]	864357 € 11,50 [26]	864557 € 7,67 [26]	864657 € 7,67 [26]
	TV-SAT Dose 	864056 € 14,40 [26]	864154 € 7,67 [26]	864354 € 11,50 [26]	864554 € 7,67 [26]	864654 € 7,67 [26]
	TV Dose 	864053 € 11,70 [26]	864151 € 7,67 [26]	864351 € 11,50 [26]	864551 € 7,67 [26]	864651 € 7,67 [26]
RJ 45 DOSEN – KAT. 6A						
Einzeldose – UTP		864044 € 26,95 [26]	864142 € 5,74 [26]	864342 € 8,19 [26]	864542 € 5,47 [26]	864642 € 5,47 [26]
Einzeldose – STP		864048 € 26,60 [26]	864142 € 5,74 [26]	864342 € 8,19 [26]	864542 € 5,47 [26]	864642 € 5,47 [26]
Doppeldose – UTP		864045 € 32,60 [26]	864143 € 5,71 [26]	864343 € 8,58 [26]	864543 € 5,71 [26]	864643 € 5,71 [26]
Doppeldose – STP		864049 € 32,50 [26]	864143 € 5,71 [26]	864343 € 8,58 [26]	864543 € 5,71 [26]	864643 € 5,71 [26]
TELEFONDOSEN						
TAE / TDO Telefondose		775991 / 775990 € 14,85 / € 48,75 [21] / [21]	864168 € 5,29 [26]	864368 € 7,93 [26]	864568 € 5,29 [26]	864668 € 5,29 [26]
GLASFASER-STECKDOSE						
SC/APC Monomode-Glasfaser-Steckdose		–	864144 ⁽¹⁾ € 50,85 [26]	864344 ⁽¹⁾ € 62,70 [26]	864544 ⁽¹⁾ € 54,45 [26]	864644 ⁽¹⁾ € 50,85 [26]
BESCHALLUNG						
Bluetooth Modul mit Netzgerät		–	864148 ⁽¹⁾ € 350,05 [26]	864348 ⁽¹⁾ € 383,65 [26]	864548 ⁽¹⁾ € 350,05 [26]	864648 ⁽¹⁾ € 350,05 [26]
Lautsprecheranschluss, 2-fach		–	864149 ⁽¹⁾ € 24,65 [26]	864349 ⁽¹⁾ € 30,50 [26]	864549 ⁽¹⁾ € 24,65 [26]	–
THERMOSTAT						
Thermostat 230 V AC, 8 A		864067 € 100,55 [27]	864167 € 7,81 [26]	864367 € 11,70 [26]	864567 € 7,81 [26]	864667 € 7,81 [26]

1: inkl. Einsatz
2: Komplettes Produkt

Niloe™ Step

Zubehör

Funktion	EINSÄTZE	NILOÉ STEP ABDECKUNGEN				
		Ultraweiß 	Aluminium 	Schwarz 	Sand 	
ZUBEHÖR						
Kabelausschl		864080 € 9,51 [26]	864178 € 4,42 [26]	864378 € 6,13 [26]	864578 € 4,42 [26]	864678 € 4,42 [26]
Kabelausschl IP 44		–	864136 ⁽²⁾⁽³⁾ € 16,70 [26]	–	–	–
Aufputzgehäuse, 1-fach		–	864181 € 9,59 [26]	–	–	864681 € 10,38 [26]
Aufputzgehäuse, 2-fach		–	864182 € 18,15 [26]	–	–	864682 € 18,15 [26]
Blindmodul + Mosaic™ Adapter		–	864179 ⁽¹⁾ € 9,25 [26]	864379 ⁽¹⁾ € 13,85 [26]	864579 ⁽¹⁾ € 9,25 [26]	864679 ⁽¹⁾ € 9,25 [26]





1: inkl. Einsatz

2: Komplettes Produkt

3: Für die IP 44-Einsätze werden die Standard-Abdeckrahmen zur Komplettierung verwendet.

Niloe™ Step

Auswahltabelle Rahmen

FARBE	RAHMEN				
	1-fach	2-fach	3-fach	4-fach	5-fach
					
<input type="radio"/> Ultraweiß	864171 € 2,53 [26]	864172 € 4,39 [26]	864173 € 7,24 [26]	864174 € 12,40 [26]	864175 € 21,20 [26]
<input type="radio"/> Ultraweiß IP 44 mit Klappdeckel	864071 ⁽²⁾ € 28,10 [26]	-	-	-	-
<input type="radio"/> Ultraweiß mit Beschriftungsfeld	864161 ⁽¹⁾ € 4,08 [26]	-	-	-	-
<input checked="" type="radio"/> Aluminium	864371 € 3,81 [26]	864372 € 6,59 [26]	864373 € 10,85 [26]	864374 € 18,65 [26]	864375 € 31,65 [26]
<input checked="" type="radio"/> Aluminium mit Beschriftungsfeld	864361 ⁽¹⁾ € 6,10 [26]	-	-	-	-
<input checked="" type="radio"/> Schwarz	864571 € 2,53 [26]	864572 € 4,39 [26]	864573 € 7,24 [26]	864574 € 12,40 [26]	864575 € 21,20 [26]
<input checked="" type="radio"/> Schwarz mit Beschriftungsfeld	864561 ⁽¹⁾ € 4,08 [26]	-	-	-	-
<input checked="" type="radio"/> Sand	864671 € 2,53 [26]	864672 € 4,39 [26]	864673 € 7,24 [26]	864674 € 12,40 [26]	864675 € 21,20 [26]
<input checked="" type="radio"/> Sand mit Beschriftungsfeld	864661 ⁽¹⁾ € 4,08 [26]	-	-	-	-

1: Rahmen mit Beschriftungsfeld sind nur für horizontale Montage geeignet.
 2: Für den Einbau von Standard-Einsätzen zur Erhöhung auf Schutzart IP 44. (Einbauhöhe der Einsätze beachten.)

FOLGEN SIE UNS AUF

@ unserer Webseite

 LinkedIn

 Xing

 Instagram

 Facebook

 Youtube

Legrand GmbH

Am Silberg 14
59494 Soest

T 0 29 21/104-0
info.service@legrand.de
www.legrand.de

Technische Beratung und Angebote

• MyHOME/Hausautomation

T 0 29 21/104-141

• Installationsmaterial/Schalter

T 0 29 21/104-144
info.technik@legrand.de

Verkaufsservice

T 0 29 21/104-0
de-verkaufsservice@legrand.de

Legrand behält sich das Recht vor, die erforderlichen technischen Änderungen oder Verbesserungen an den Produkten vorzunehmen und die erwähnten Maße ohne vorherige Mitteilung zu ändern.